

LED LIGHTING SOLUTIONS

COMMERCIAL - RESIDENTIAL - INDUSTRIAL

2021/22



REXEL

a world of energy

Live and work in a better light

The LED market offers great opportunities for our customers, but rapid advances in technology can make product selection challenging. Rexel's expertise in all sectors of the lighting market and relationships with leading suppliers guarantee that we will always offer a wide range of quality products you can trust, at the right price, when and where they are needed.

Only the best is good enough



We deliver FREE

Our 200+ branch network means nationwide availability of our LED solutions products with a FREE same and next day delivery service for stock items (order by 12noon for same day and by 5pm for next day) or click and collect: www.rexel.co.uk



We advise

We have expertise in every sector whether commercial, residential or industrial and offer unbiased solutions, so you get more than just a product when you buy from Rexel



We track

We track all the latest technologies and product developments, so you can tap into new business opportunities



We check

We get involved in the design process from start to finish, and insist that products are fully tested against strict criteria before we add them as a product line



We comply

All products are CE marked and certified as fully compliant to UK standards ensuring peace of mind for both you and your customers. Products will also be fully compliant with the new UKCA requirements that are being introduced from January 2022.



We time-save

We have integrated numerous easy to install and time saving features to make things easier for you.



We care

We take our corporate responsibility seriously, from the products we sell to the way we run our business. We work hard to do the best we can for our customers, our employees, our local communities, and the environment we all share. Strict auditing allows us to source all our LED products from a fully traceable, sustainable and ethical supply chain.





Why choose LED from Rexel?

See things in a better light...

- Improved quality, efficiency and performance
- Instant on flicker free light
- Energy saving of up to 93%
- Easy installation and retrofitting – 1:1 replacement for traditional products
- Environmentally friendly - LEDs do not contain any harmful materials, making them easier to dispose of and give out no UV or IR emissions
- A quick initial payback on investment
- Ongoing long-term energy and cost savings for your business
- LEDs last significantly longer than traditional lamps, so maintenance costs are significantly reduced

High Quality Drivers

All of our commercial and industrial luminaires come with either a leading branded driver such as Osram or Tridonic or a driver that has been ENEC certified, so you can be confident they have been tested to the highest standards in performance and safety and won't let you down.

Standard Luminaires Warranty^{†*}

Rexel offers a minimum 3 year warranty on all products that have been correctly specified, professionally installed and operated in line with the instruction leaflet.

[†] If a product was to fail during this period Rexel will arrange for the product to be repaired or replaced with an equal or substitute product at our discretion.

^{*} Wearing or consumable parts such as fuses and emergency lighting batteries are exempt from the guarantee. All sales are subject to Rexel UK Limited standard terms and conditions of sale. In the event of any conflict between the wording set out in this document and the standard terms, the standard terms of Rexel UK Limited shall prevail.

LED Lighting Solutions - Contents



Page 14 Commercial Lighting

15
LED Edge-Lit
Panel



16
LED Back-Lit
Panel

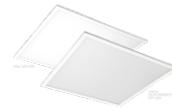

17
Anna Vario
Recessed LED
Panel - Colour
Selectable



18
LED Backlit
Panel - Elite
High Efficiency
7 Year Warranty



19
LED Panel -
IP65



20
LED Edge-lit
Circular Panel/
Downlight



21
LED
Commercial
Downlight



22
Zoe Vario Slim
LED Downlight
- Colour
Selectable



23
Amy Vario
Recessed LED
Downlight
- Colour
Selectable



24
LED Surface
Linear



25
Surface Linear -
Surface Movable
IK08



Page 26 Emergency Lighting

29
LED Emergency
Bulkhead



30
LED Emergency
Suspended Exit
Sign



31
LED Emergency
Wall Exit Box



32
Arlington Pro



34
LED Emergency
Escape Route



35
LED Emergency
Twinspot



36
RoundTech



37
Flexitech



38
NexiLite/
Nexitech LED



39
BeamLite II



40
Zeta 4



Our terms and conditions of sale apply to the sale of goods to the exclusion of all other terms. A copy of our terms is available at www.rexel.co.uk. The information in this document is for general information purposes only. Rexel UK Limited assumes no responsibility in so far as the law permits for errors or omissions in the contents of this document. No reliance shall be placed on the contents by readers.

All information correct at time of going to print. E. & O.E. Unless indicated otherwise, all equipment featured in this catalogue is produced by third party manufacturers.

A complete range for all applications

Rexel's LED lighting range offers complete solutions regardless of the application. Whether it is a highbay for an industrial environment, a panel for commercial offices or a downlighter for a kitchen, all of our products offer a true direct replacement for traditional fittings and have been tested to ensure the highest performance and quality.

Page 42 Industrial Lighting

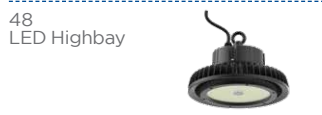

Page 52 Floodlights

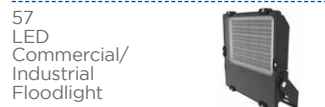
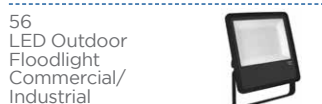
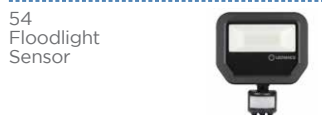
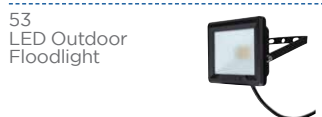

Page 58 Amenity Lighting

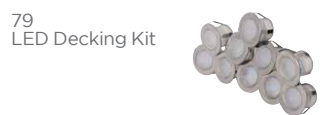
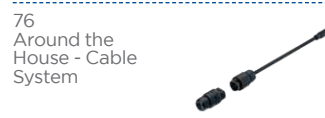
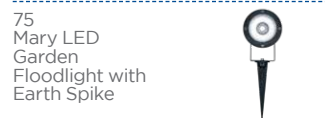
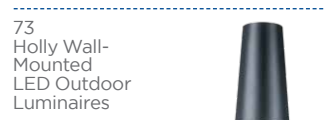
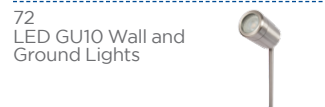
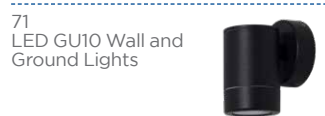
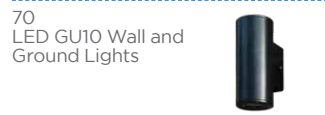
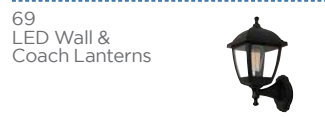
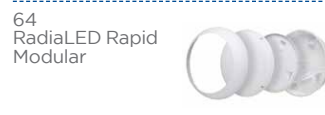
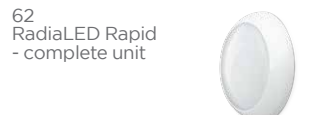
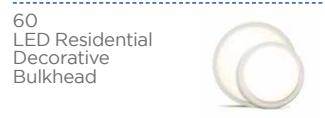

Page 82 Street Lighting

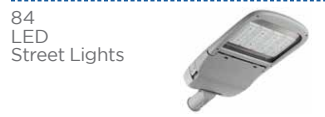
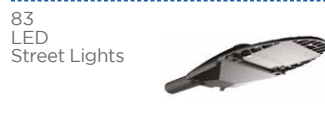

Page 86 Site Lighting

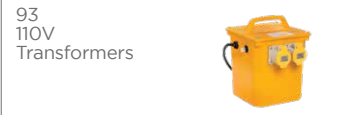
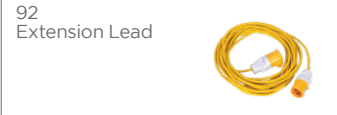
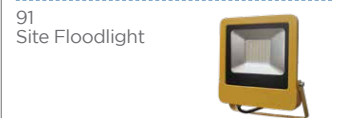
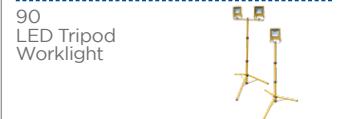
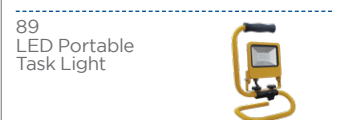
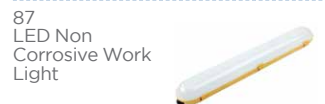

Page 94 Hazardous Area

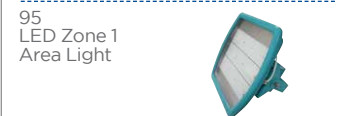

LED Lighting Solutions - Contents



Page 98 Display Lighting

99
LED 240V GU10
Downlights



100
LED Fire
Rated GU10
Downlights



101
LED Integrated
Downlights



102
LED Fire Rated
Downlights
Colour
Switchable



104
V50™ - Fire
Rated LED
Downlight



105
V50™ Tilt - Fire
Rated LED
Downlight



106
LED Track
Lights



107
LED Spotlights



108
LED Flexi-Strip



110
LED Link Lights



111
LED
Undercabinet
Lights



112
LED Shaverlight



Page 114 Lamps

115
LED GLS



116
CorePro LED
Frosted GLS
Non Dimmable



117
Master Value
LED Frosted
GLS Dimmable



118
Master Value
LED Filament
GLS Dimtone



119
Master LED GLS
Dimtone



120
LED Candle



121
CorePro LED
Filament Candle
Non Dimmable



122
Master Value
LED Candle
DimTone



123
Master Value
LED Filament
Candle Dimtone



124
LED GU10



125
CorePro LED
GU10



126
Master Value
LED GU10



127
LED MR16



128
CorePro LED
MR16 Non
Dimmable



129
Master Value
LED MR16
Dimmable



130
LED G4 G9



131
LED T8 Tubes



132
CorePro LED
Tube



134
LED Smart
Lamps



Page 136 Lighting Controls

137
Stand Alone PIR



138
Photocells



140
Vive by Lutron



142
RA2 Select by
Lutron



Live in a Better Light

Take home lighting to the next level with innovation from Rexel Lighting Solutions. Whether your needs are functional or decorative, interior or exterior, we can help you bring those areas to life!

Whatever the project scale, we make things easy, with expert advice on LED technology and all the quality brands.



Pictured: Nanoleaf Shapes. Rethink what's possible with dynamic and truly limitless customizable lighting to create stunning lighting mosaics perfect for any occasion.

Contact us for more info:

Lighting.solutions@rexel.co.uk

Or find your local branch: [rexel.co.uk/store-finder](https://www.rexel.co.uk/store-finder)

REXEL

a world of energy

Better LED Solutions for every sector



Lighting Design and Solutions



End to end support and expertise for all your lighting projects

When it comes to lighting projects, we can help you do it better! We offer a free of charge bespoke lighting design service that will help you achieve the creative, energy efficient and cost-effective solution that will deliver outstanding results, whether your project is commercial, residential or industrial.

Our team can be part of your team – our Project Management service from concept to completion relieves you of all the challenges of maintaining design integrity and continuity throughout the job.

Here's how...

Stage 1: Survey, advice and calculations

- Nationwide team of engineers professionally qualified to industry standards
- Free on-site energy saving surveys together with cost of ownership proposals and payback calculations
- Impartial advice – we are not affiliated to any particular lighting manufacturer
- Can advise on cost and pay back solutions (both long and short term) reducing the end client's operational costs

Stage 2: Design service

- We can work from drawings supplied by you, to create a bespoke lighting solution for your project location
- Technical design calculations and layouts are created using the latest RELUX software package
- Designs conform to the latest CIBSE/SLL guides & British Standards

Stage 3: Quality Products

- We can involve multiple Rexel lighting suppliers to help with your requirements
- We recommend only trusted products from the world's leading lighting manufacturers that meet our rigorous standards of performance, safety and quality

Stage 4: Installation

- Based on information that we have gathered from our survey and lighting designs, we can facilitate an installation service linking you with installers to give you a 'one-stop' solution which is fully project-managed
- We can of course, also work on a supply only basis

Contact us for more info:

Find your local branch: <https://www.rexel.co.uk/uki/store-finder>

Email the Lighting Design and Solutions Team: lighting.solutions@rexel.co.uk

A better **Industrial** light

An industrial environment requires a highly functional solution that must often meet strict criteria. Our Rexel Industrial Solutions team and network of Industrial branches have your lighting needs covered, and with the support from our Rexel Lighting Solutions team based in Droitwich, they can offer expert advice and have the ability to supply all your specialist lighting requirements.

We can quickly source or provide from extensive stocks, rare or unusual products that you may need to replace, or discontinued items you simply cannot find elsewhere. All orders are despatched the same day from stock directly to site or your local branch, packaged and handled with great care to ensure even the most delicate items arrive on time and completely intact.

Our Industrial lighting categories

- Highbays (IND165v3-C10, IND166v3-C10, IND167v3-C10)
- Lowbays (IND240, IND241), LED Midibay
- Floodlight (FLD150-D1, FLD151-D1, FLD153-D1)
- LED Non-corrosive



Our Industrial lighting solutions

- Control gear and spares
- We can source those hard to find specialist or obsolete products
- Lighting surveys and return on investment reports
- Lighting design service
- Support for applications for funding and finance agreements
- Supply and install – we can link you with installers
- End to end project management
- Industrial fuses



Our Industrial Sector expertise

- Aerospace
- Automotive
- Aggregates
- Chemicals
- Food and Beverage
- Glass
- Heavy Manufacturing
- Metals
- Nuclear
- OEMS
- Petrochemicals
- Pharmaceuticals
- Packaging
- Recycling
- Utilities



Contact us for more info:

Email the Industrial Team: industrial.enquiries@rexel.co.uk **Call:** 0333 400 5938

Find your local branch: <https://www.rexel.co.uk/uki/store-finder>

Find your nearest Industrial branch: <https://www.rexel.co.uk/uki/industrial>

A better **Residential** light

Residential lighting has significantly evolved in recent years with LED developments that provide a whole range of enhanced options such as various colour temperatures, dimming, Smart controls and colour changing lamps.

With increased use of residential outdoor spaces, the demand for creative and functional exterior lighting is surging, whether for security, decorative or outside entertaining purposes, we can help you bring those areas to life!

Whatever the project scale, we make things easy – we have the expertise to give you the best recommendations from all the leading brands. Our products are high in quality, performance and safety so you can 'fit and forget' trusting that your client's expectations will be met.

Our Residential lighting categories

- LED Integrated Downlights/Fire rated Downlight
- LED GU10 wall and ground lights
- LED Residential Decorative Bulkhead
- LED GLS, Candles, MR16, GU10, Smart Lamps



Our Residential lighting solutions

- Control gear and spare parts for your light fittings
- Expert advice on latest LED technology
- Smart Homes products and recommendations. View our catalogue and guide here: <https://rexel-interactive-catalogues.rexel.co.uk/index.php?catalog=Smart-home-2020>

Our Residential Sector expertise

- Social Housing
- Housing Associations
- House builders
- University campus accommodation
- Supporting the smaller contractors with private dwelling installs



Contact us for more info:

Find your local branch: <https://www.rexel.co.uk/uki/store-finder>

A better **Commercial** light

We understand the needs of those in the commercial and public sector environment whether you are an installer or the end-user. Working in a better light has never been more important, with so many factors to consider such as the wellbeing and safety of building users, suitability for the building function, frequency of maintenance, energy and cost-saving targets to be met as well as aesthetics.

We can provide support right from the design stage through to project completion to ensure the end result delivers in all of those categories and is completed within your deadlines.

Our Lighting Design and Solutions Team have the expertise to assist with all the guidance you need, and if you are a Facilities Management organisation, our FM Team are specialists in your sector needs.

Our Commercial lighting categories

- LED Panel Back/Edge-Lit, LED Panel – IP65, Elite
- LED Batten
- LED Commercial Downlight
- LED Surface Linear
- LED Floodlight



Our FM lighting categories

- Fire rated downlight
- LED Bulkhead
- LED GLS, Candles, MR16, GU10
- Emergency Lighting



Our Commercial lighting solutions

- Dedicated Account Managers at local and national levels
- Lighting surveys and return on investment reports
- Energy audits
- Lighting design service (see page 9 for full details)
- Control gear, spare parts and critical spares for your light fittings including specialist and obsolete products
- Consignment stock
- End to end project management (new and retro-fit)



Our Commercial and Public Sector expertise

Public sector

- Health
- Education
- Social Housing
- Transport
- Government

Private sector

- Commercial
- Retail
- Hospitality and Leisure
- Government



Contact us for more info:

Find your local branch: <https://www.rexel.co.uk/uki/store-finder>

FM customers

FM Contact Centre: 0330 045 0606 **Email:** customer.connect@rexel.co.uk



**“CAN I REALLY
GET EVERYTHING
I NEED ONLINE?”**

**DON'T WORRY, YOU'LL FIND EVERYTHING
FROM THE ESSENTIALS TO MORE UNUSUAL ITEMS HERE.
MAKE US YOUR ONE STOP SHOP.**

**350,000 PRODUCTS
AVAILABLE AT REXEL.CO.UK**

Including:

- Over 140 manufacturer brands
- Newlec — our market leading own brand
- A wide range of electrical, smart homes, industrial, site supplies and energy products

Rexel

a world of energy

Download our app:



Commercial Lighting



LED Edge-Lit Panel

An edge-lit LED flat panel equivalent for the 600x600mm and 1200x600mm recessed modular luminaires that offer significant energy and maintenance savings. Suitable for a wide range of applications such as breakout areas, offices and meeting rooms and any other general indoor area. They can also be suspended or surface mounted with additional kits.

- ✓ Rigid aluminium frame in white RAL9016
- FIT + FORGET** Simple installation with loop-in/loop-out
ENEC branded driver
- 👍 Flicker free LED driver
- ✓ Separate plug in emergency kit to convert standard panel into emergency 3 hour option



	PANEL TP(B) RATED	PANEL TP(A) RATED
BODY MATERIAL	ALUMINIUM FRAME RAL 9016	
DIFFUSER MATERIAL	OPAL PLYCARBONATE DIFFUSER TP(B) RATED	OPAL PLYCARBONATE DIFFUSER TP(A) RATED (SELF EXTINGUISHING)
CRI	> 80	
COLOUR TEMPERATURE (K)	4,000	
IP RATING	44	44
UGR RATING < 19	NO	YES
ELECTRICAL CLASS	2	2
ECA COMPLIANCE	YES	YES

Order No.	Model No.	Description	Wattage (W)	Lumens (lm)	Efficacy (Lm/W)
2501157621	NFU/O/66/840	600x600 LED PANEL TPB	32	3465	108
2501157622	NFU/O/126/840	1200x600 LED PANEL TPB	55	6370	116
2501157623	NFU/UGR19/66/TPA/840	600x600 LED PANEL TPA	31	3400	110





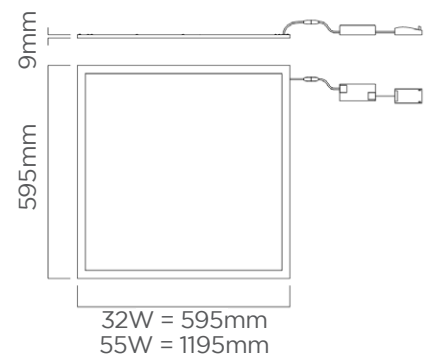

Accessories

2501157624	N/REC/M3/PACK/V2	REMOTE EMERGENCY PACK 3 HOUR FOR LED PANELS
2501157625	NFU/WIRE/SUSP/KIT	WIRE SUSPENSION KIT FOR PANEL
2501157626	NFU/SMK/66	SURFACE MOUNTING KIT FOR 600X600 PANEL
2501157627	NFU/SMK/126	SURFACE MOUNTING KIT FOR 1200X600 PANEL



LED Back-Lit Panel

A range of back-lit LED panels suitable for replacing fluorescent 600x600mm or 1200x600mm recessed modular fittings. The back-lit panels can be recessed or surface mounted and are suitable for general indoor lighting applications such as breakout areas, offices and meetings rooms.

-  Steel body provides additional heat dissipation and will not warp or bend unlike plastic options
-  PMMA diffuser will not go yellow or sag out of the panel over time unlike lower quality options
-  Loop-in / Loop-out driver for quick and simple installation
-  ENEC branded driver for improved quality and performance
-  Consistent uniform light with no dark spots or visible flicker
-  Separate plug-in emergency 3 hour pack allows standard panels to be converted to emergency panels for flexibility

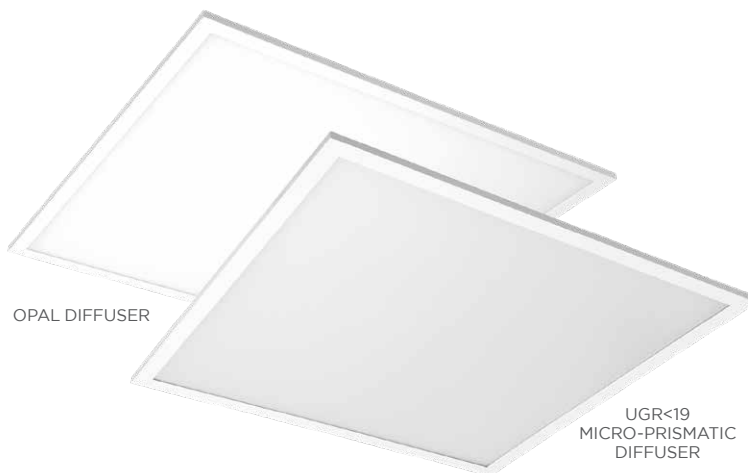

	PANEL TP(B) RATED	PANEL TP(A) RATED
BODY MATERIAL	ALUMINIUM FRAME RAL 9016	
DIFFUSER MATERIAL	OPAL POLYCARBONATE DIFFUSER TP(B) RATED	MICRO PRISMATIC DIFFUSER TP(A) RATED (SELF EXTINGUISHING)
CRI	>80	>80
COLOUR TEMPERATURE (K)	4000	4000
IP RATING	44	44
UGR RATING < 19	NO	YES
ELECTRICAL CLASS	2	2
ECA COMPLIANCE	YES	YES

Order No.	Model No.	Description	Wattage (W)	Lumens (lm)	Efficacy (Lm/W)
2501310708	NFO/O/66/840	600x600 LED PANEL TPB	29.5	3413	116
2501310709	NFO/O/126/840	12000x600 LED PANEL TPB	59	6300	107
2501310710	NFO/UGR19/66/TPA/840	600x600 LED PANEL TPA	29.2	3475	119

Accessories

2501157624	N/REC/M3/PACK/V2	REMOTE EMERGENCY PACK 3 HOUR FOR LED PANELS
2501310711	NFO/SMK/66	SURFACE MOUNTING KIT FOR 600X600 PANEL
2501310712	NFO/SMK/126	SURFACE MOUNTING KIT FOR 1200X600 PANEL





Anna Vario Recessed LED Panel - Colour Selectable

Low glare and calm, Anna Vario is the universal talent for desk space environments. Ideal for offices, schools and universities.



Material Construction

- Frame: Aluminum, white (RAL 9003)
- Diffuser: TpB rated, PET, opal
- Light guide plate: PS
- Backplate: Steel sheet



Three colour temperatures in one product – simply select 3000 K (warm white), 3500 K or 4000 K (neutral white) to suit the application use



Gentle, soft and glare free lighting (UGR <19)



Even Surface and IP44 (from below) for hassle-free cleaning



Order No.	Model No.	Description	Emergency	Wattage (W)	Lumens (lm)	Efficacy (Lm/W)	Colour Temperature (K)
2501355942	96634030	ANNA VARIO 600X600 Q596	YES WITH ACCESSORY	29	3003	104	3000K, 3500K, 4000K
2501355943	96634032	ANNA VARIO 600X600 Q596	YES WITH ACCESSORY	34	3754	110	3000K, 3500K, 4000K
2501355944	96634034	ANNA VARIO Q596 HFIX	YES WITH ACCESSORY	34	3754	110	3000K, 3500K, 4000K

Accessories

2501355947	96634443	ANNA VARIO Q596 RECESSED MOUNT BOX
2501355948	96634444	ANNA VARIO Q596 SLIM SURFACE MOUNT BOX
2501361223	96634428	E3 EMERGENCY PLUG&PLAY KIT SELFTEST LIFEPO4

5
YEAR
WARRANTY

CCT
SWITCH

IP20
/44

IK03

50,000H
@L80

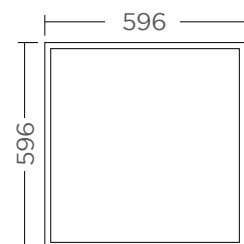

LED Backlit Panel - Elite High Efficiency 7 Year Warranty

The Backlit Panel Elite pushes the boundaries of panel design to deliver highly efficient, low glare lighting with an impressive 7 year warranty. Lower running costs over a longer warranty period make this panel one of the most economic panels over the life of the fitting.



Material Construction

- Steel body - white RAL 9016
- Aluminium frame
- Prismatic TP(a) rated diffuser



Prismatic diffuser for low glare, achieving <19UGR for ultimate user comfort



Highly efficient LED chips achieving 135lm/W. Lowering energy costs



Emergency 3 hour remote pack available



High lumen maintenance - 80% light output after 50,000Hrs operation



Flicker free driver



Order No.	Model No.	Description	Wattage (W)	Lumens (lm)	Efficacy (Lm/W)	Colour Temperature (K)
2501401098	PNL084-KIT01	BACKLIT PANEL - ELITE	24	3250	135	4000

Accessories

2501360201	EMG018V2	3W LED EMERGENCY REMOTE PACK
2501142328	ACS057	BOX SURFACE MOUNT FOR 600X600 LED PANEL
2501360192	ACS198	SUSPENSION KIT
2501360203	ACS199	BACKLIT PANEL RECESS KIT

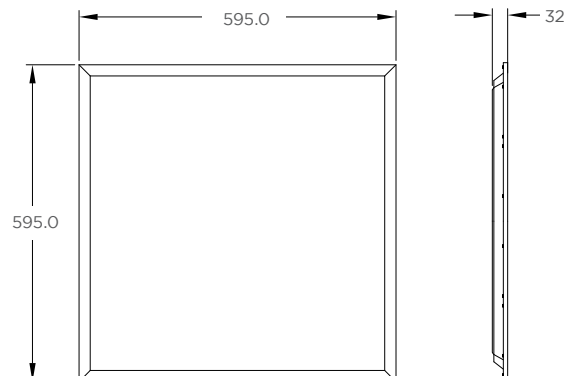
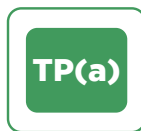



VENTURE
LIGHTING

LED Panel – IP65

An edgelit panel, protected by a specifically designed, inbuilt closed-cell gasket providing IP65 protection on the front-face. Suitable for wet locations such as locker rooms and laboratories.



Material Construction

- Aluminium Frame - RAL9016
- Opal Polystyrene Diffuser



Suitable for wet locations



Supplied with flicker free, loop in loop out driver



Plug and play Emergency 3 hour remote pack available



Order No.	Model No.	Description	Wattage (W)	Lumens (lm)	Efficacy (Lm/W)	Colour Temperature (K)
2501230727	PNL060-KIT01	30W LED PANEL - 600X600MM, IP65	30	3150	105	4000

Accessories

2501360201	EMG018V2	3W LED EMERGENCY REMOTE PACK
------------	----------	------------------------------

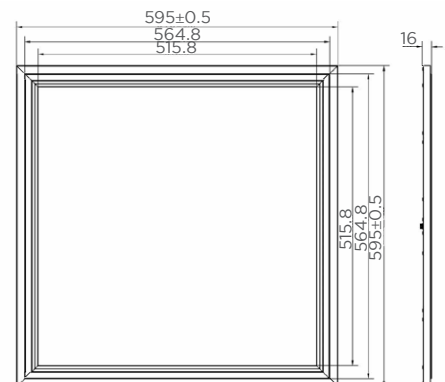

LED Edge-lit Circular Panel / Downlight

A range of edge-lit circular panels suitable for replacing downlights or compact fluorescent (CFL) downlights with cut-outs from 110mm to 210mm. Suitable for use in commercial and residential general indoor lighting applications.



Materials

- Aluminium frame - white RAL9016
- Opal polycarbonate diffuser



Separate plug-in emergency 3 hour pack allows standard panels to be converted to emergency panels for flexibility



Easy to clean wipeable diffuser

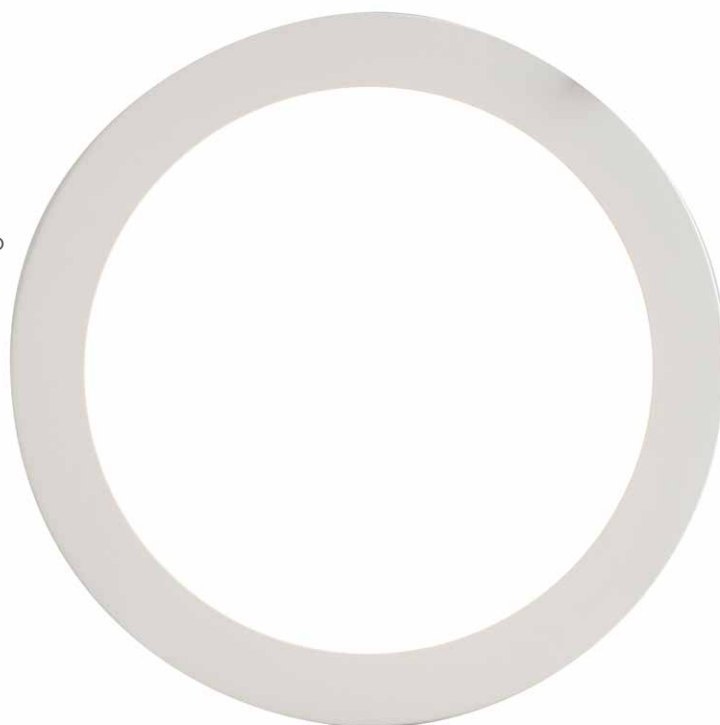

Order No.	Model No.	Description	Wattage (W)	Lumens (lm)	Efficacy (Lm/W)	Colour Temperature (K)
2501120799	ELP12W6L40	120MM LED CIRCULAR PANEL	6	360	60	4000
2501120800	ELP15W9L40	150MM LED CIRCULAR PANEL	9	630	70	4000
2501120801	ELP17W12L40	170MM LED CIRCULAR PANEL	12	900	75	4000
2501120802	ELP22W18L40	220MM LED CIRCULAR PANEL	18	1530	85	4000

Accessories

2501120803	LED3EP80	EMERGENCY PACK FOR CIRCULAR PANEL AND COMMERCIAL DOWNLIGHTS
------------	----------	---



ELP12W6L40-02



ELP17W12L40-02

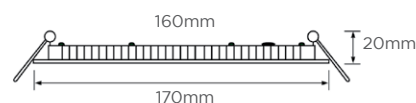

ELP15W9L40-02

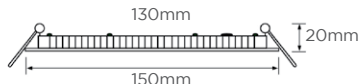

ELP22W18L40-02

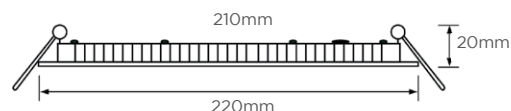

LED Commercial Downlight

An integrated LED downlight replacement for compact fluorescent (CFL) downlights with cut-outs from 175mm to 210mm. Suitable for general indoor commercial lighting applications such as offices and corridors.



Materials

- Aluminium body - white RAL 9016
- Polycarbonate housing
- Opal polycarbonate diffuser - self extinguishing TP(b) rated



Plug-in emergency 3hr kit available



Quick and easy install with with plug and play loop in loop out driver



Easy to clean wipeable diffuser



Order No.	Model No.	Description	Wattage (W)	Lumens (lm)	Efficacy (Lm/W)	Colour Temperature (K)
2501120804	LBDL6S40	197MM LED COMMERCIAL DOWNLIGHT	15.5	1500	96.7	4000
2501120805	LBDL8S40	244MM LED COMMERCIAL DOWNLIGHT	22	2000	90.9	4000

Accessories

2501120803	LED3EP80	EMERGENCY PACK FOR CIRCULAR PANEL AND COMMERCIAL DOWNLIGHTS
------------	----------	---

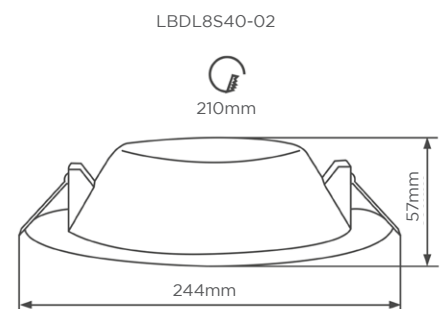
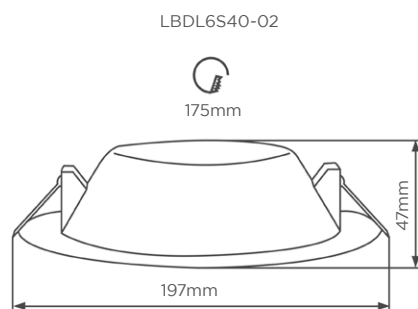



Zoe Vario Slim LED Downlight - Colour Selectable

Slim and adaptable, Zoe Vario is perfectly suited to everyday needs. Ideal for corridors, reception areas, offices, schools and universities.



Material Construction

- Body: Aluminum, white finish
- Diffuser: PS



Three colour temperatures in one product – simply select 3000 K (warm white), 3500 K or 4000 K (neutral white) to suit the application use



Product height of only 26mm to fit various ceiling types



Flat Surface and IP44 for hassle-free cleaning



Connector for tool-free wiring, also enabling loop-in loop-out



Suitable to use with the Just Emergency PLUG&PLAY E3 KIT for 3 hours emergency operation (separately available)



Order No.	Model No.	Description	Emergency	Wattage (W)	Lumens (lm)	Efficacy (Lm/W)	Colour Temperature (K)
2501285064	96632685	ZOE VARIO LED DL 130MM	YES WITH ACCESSORY	9	700	78	3000K, 3500K, 4000K
2501285065	96632686	ZOE VARIO LED DL 170MM	YES WITH ACCESSORY	12	1000	83	3000K, 3500K, 4000K
2501285066	96632687	ZOE VARIO LED DL 210MM	YES WITH ACCESSORY	18	1600	89	3000K, 3500K, 4000K
2501285067	96632688	ZOE VARIO LED DL 210MM	YES WITH ACCESSORY	22	2000	91	3000K, 3500K, 4000K

Accessories

2501361223	96634428	E3 PLUG&PLAY KIT SELFTEST LIFEPO4
------------	----------	-----------------------------------

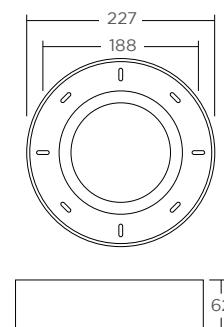
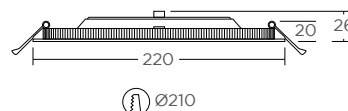
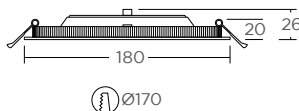
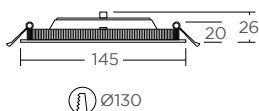



Amy Vario Recessed LED Downlight - Colour Selectable

With a pleasing aesthetic, Amy Vario is the ideal solution for a vast range of applications. Ideal for corridors, reception areas, offices, schools and universities.



Material Construction

- Body: Steel, white finish (RAL 9003)
- Diffuser: Polycarbonate



Three colour temperatures in one product – simply select 3000 K (warm white), 3500 K or 4000 K (neutral white) to suit the application use



The fully detachable connector allows for first fix wiring and high voltage circuit testing whilst the luminaire is detached from the connector



External connector box with a 4-pole push terminal enabling loop-in loop-out wiring



Suitable for use with phase-cut dimmer switches from approved manufacturers



Consistent light output with no shadowing



Dimmable



Order No.	Model No.	Description	Emergency	Wattage (W)	Lumens (lm)	Efficacy (Lm/W)	Colour Temperature (K)
2501349847	96632753	AMY VARIO 100MM LED DL	YES WITH ACCESSORY	7	700	100	3000K, 3500K, 4000K
2501349848	96632754	AMY VARIO 150MM LED DL	YES WITH ACCESSORY	10	1000	100	3000K, 3500K, 4000K
2501349839	96632755	AMY VARIO 150MM LED DL	YES WITH ACCESSORY	15	1500	100	3000K, 3500K, 4000K
2501349840	96632756	AMY VARIO 200MM LED DL	YES WITH ACCESSORY	20	2000	100	3000K, 3500K, 4000K

Accessories

2501361223	96634428	JUST E3 PLUG&PLAY KIT SELFTTEST LIFEPO4
------------	----------	---

5
YEAR
WARRANTY

CCT
SWITCH

IP44

50,000H
@L80

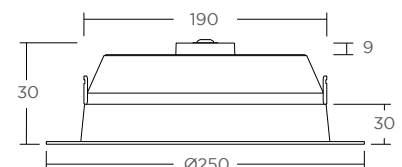
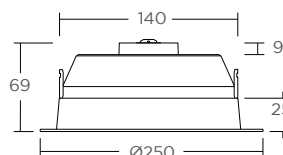
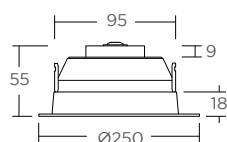

LED Surface Linear

LED Equivalents to 4ft & 5ft linear fluorescent fittings perfect for any education or commercial environment as it delivers low energy LED technology without compromising on quality.



Material construction

- Steel Body - white RAL 9003
- Polycarbonate diffuser



Low glare - UGR19 rated (Unified Glare Rating)



Anti-tamper end caps preventing unauthorised entry



Emergency 3 hour options available



Order No.	Model No.	Description	Emergency	Wattage (W)	Lumens (lm)	Efficacy (Lm/W)	Colour Temperature (K)
2501182987	COM014	4FT LED SURFACE LINEAR		28	4000	129	4000
2501182988	COM014-EM	4FT LED SURFACE LINEAR	Y	28	4000	129	4000
2501182989	COM015	5FT LED SURFACE LINEAR		32	4700	134	4000
2501182990	COM015-EM	5FT LED SURFACE LINEAR	Y	32	4700	134	4000

Accessories

2501360192	ACS198	SUSPENSION KIT
------------	--------	----------------

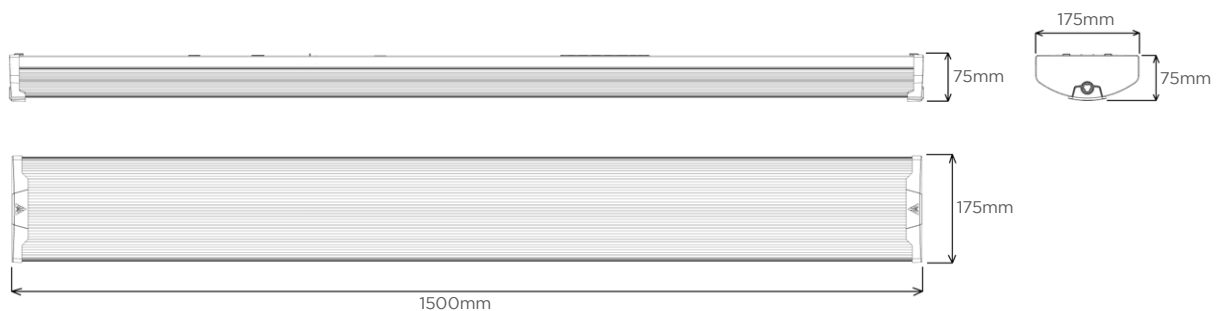

Surface Linear - Surface and Suspension Mountable IK08



Robust IP44 luminaires with direct light emission for surface or suspended applications



Material Construction

- Stainless Steel Bod (RAL 9010 finish)
- Opal polycarbonate diffuser
- Polycarbonate end caps



Suitable for surface or suspended mounting



50,000 hr life (L70 B50)



Designed for through wiring



Rear and end-cap cable entries



Push wire terminals for plug and play installation



Emergency 3 hour options available



Order No.	Model No.	Description	Emergency	Wattage (W)	Lumens (lm)	Efficacy (Lm/W)	Colour Temperature (K)
2501260768	4058075352896	LN SF 1200MM	-	36	4000	110	4000
2501283828	4058075402973	LN SF 1200MM EM	Y	36	4000	110	4000
2501260770	4058075352933	LN SF 1500MM	-	43	5000	115	4000
2501283850	4058075403017	LN SF 1500MM EM	Y	43	5000	115	4000

Accessories

2501283858	4058075607521	LN SF SUSPENSION WIRE
------------	---------------	-----------------------



4058075352896 / 4058075402973



4058075352933 / 4058075403017

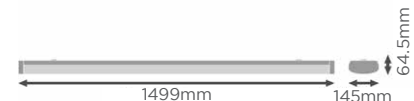

Emergency Lighting

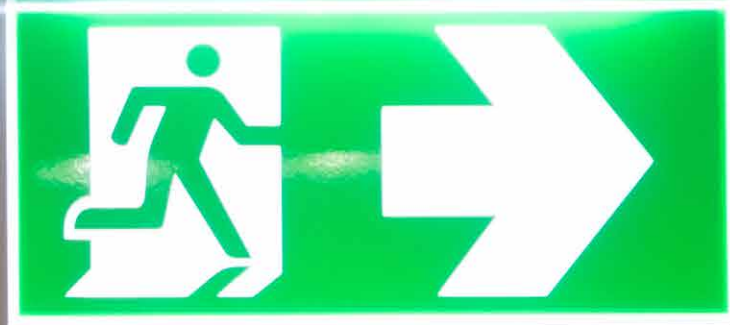

LED Emergency Lighting

Emergency lighting is primarily intended to provide sufficient illumination to enable people to navigate their way safely out of a building in case of an emergency. Legislation now demands that the person responsible for the building ensures compliance with the standards and carries severe penalties if not adhered to.

Key parts of the Fire Safety Order Directive: 2005 are:

- The responsible person has a duty to take general fire precautions
- The responsible person must complete a risk assessment
- The responsible person must make fire safety arrangements

BS566 - Emergency Lighting, the code of practice for the emergency lighting of premises

BS 5266 specifies the requirement for emergency lighting with specific lighting levels in areas of high risk, as follows:

- Kitchens
- Fire alarm control indication equipment
- First aid rooms
- Reception areas
- Treatment rooms
- Panic bars/pads
- Refuges
- Swimming pool surrounds and diving areas
- Plant, switch and winding rooms

BS 5266 specifies that luminaires are positioned:

- Along escape routes
- Over every flight of stairs so each step receives direct light
- At every change in direction
- Close to fire fighting equipment and call points
- Adjacent to any step or trip hazard
- Outside every final exit

Open area
(Symmetric - 0.5 Lux)

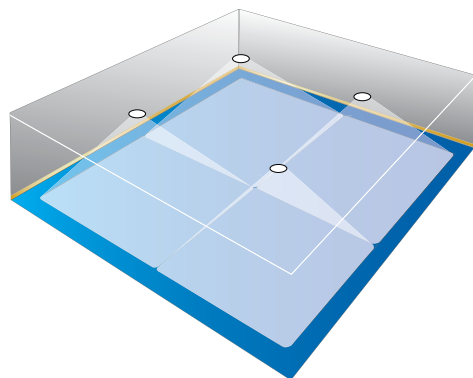

Escape Route
(Asymmetric - 1 Lux)

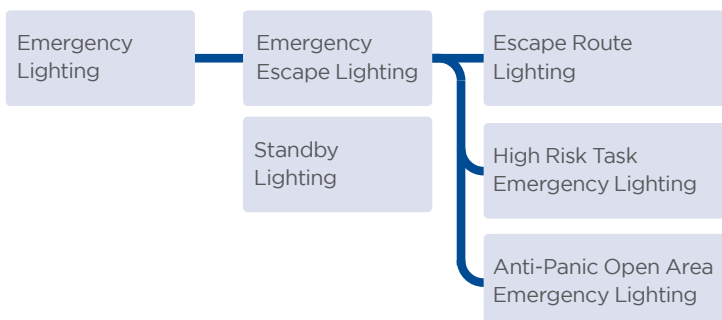
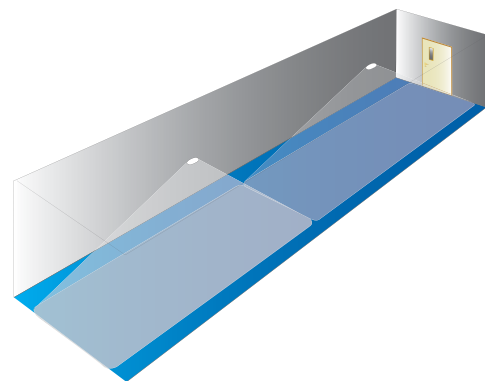

This is the most likely to be used in the event of a fire. It is necessary to allow evacuation of a building as rapidly as possible.

In hazardous areas where dangerous processes or situations need to be properly monitored, it is essential that emergency lighting systems are designed to meet the specific needs of the environment.

To avoid panic in large open areas, emergency lighting must enable people to move safely to the nearest suitable designated escape route.

LED is now the preferred light source for all emergency lighting

 **LOWER MAINTENANCE COSTS**

With old fluorescent and incandescent technologies lamps had to be changed regularly. The long life of LEDs means that this is no longer necessary, so maintenance cost are greatly reduced.

 **RELIABILITY**

Fluorescent lamps were never ideally suited to being run on batteries, so blackened lamp ends were a common problem indicating that a lamp was nearing the end of its life. LEDs are well suited to running on battery power and are therefore much more reliable.

 **BETTER LIGHT DISTRIBUTION**

Fitted with a lens, LEDs can give the precise light distribution needed for corridors.

Better light distribution means improved uniformity, better spacing and fewer fittings required to give an installation that conforms to standards.

There are only two types of exit sign legends that comply with current legislation

EUROPEAN SAFETY SIGNS DIRECTIVE

The European Safety Signs Directive calls for the following legends, which are sometimes also referred to as "Euro legends" or "man running towards door". This is the style of legend supplied as standard with Newlec emergency fittings.

There are three Euro legends in use:



"Exit to the left"



"Exit straight ahead"



"Exit to the right"

The European Safety Signs Directive is not explicit concerning the use of either an up or down-arrow to indicate "straight ahead". Both are acceptable, but we supply the arrow-down legend as standard.

Euro legends are generally used in existing installations where the format is already installed.

ISO7010 & BS5266

These two standards both use a single set of legends, sometimes referred to as "ISO7010" or "man running through door" legends. These legends are available as optional extras with Newlec emergency fittings.

There are three ISO7010 legends in use:



"Exit to the left"



"Exit straight ahead"



"Exit to the right"



Note that ISO7010 and BS5266 are explicit that "straight ahead" is to be indicated with an up-arrow.

ISO7010 legends are generally used for all new installations.

Please note: Although both legend types are in use, only one type can be used in any one installation.

LED Emergency Bulkhead

A slim multi-purpose IP65 rated LED emergency bulkhead suitable for use on corridors, exits and escape routes. A range of attachments and legends enable the bulkhead to also be used as an exit sign or double sided exit sign.

-  Supplied complete with Euro legend kit (man running towards door) to enable use as an exit sign
-  20m maximum viewing distance with standard legends
-  Drop down attachment (DDA) supplied with Euro legend kit to enable use as a double sided exit sign
-  30m maximum viewing distance with drop down attachment (DDA).
-  Can be installed in maintained or non-maintained mode (based on wiring) for flexibility
-  ISO 7010 / BS 5266 legends (man running through door) are available separately.
-  3 hour operation on battery power after mains failure



ISO7010 Legend Kit



Drop Down Attachment



Recessed Mount Kit



Order No.	Model No.	Description	Wattage (W)
1051088376	NLE3B	2W LED M/NM IP65 EMERGENCY BULKHEAD C/W EURO LEGEND	2

Accessories

1051088377	NLE3BISOL	ISO 7010 LEGEND KIT FOR NLE3B
1051088378	NLE3BRMK	RECESSED MOUNT KIT FOR NLE3B
1051088379	NLE3BDDA	DROP DOWN ATTACHMENT FOR NLE3B

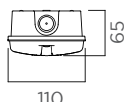
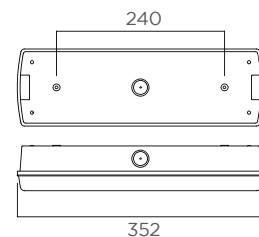
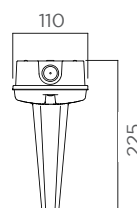
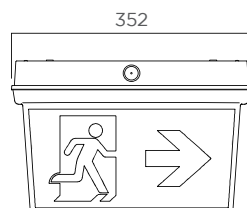

LED Emergency Suspended Exit Sign

A suspended LED exit sign with a drop blade and range of legends allowing complete flexibility in any installation.

FIT + FORGET No re-lamping or maintenance required for lifetime of the fitting

✓ Maintained operation with charge indicator lamp

△ Maximum viewing distance of 30m



Order No.	Model No.	Description	Wattage (W)
1051088380	NLE3SES	3W LED M WHITE EMERGENCY SUSPENDED EXIT SIGN C/W EURO DOWN	3

Accessories

1051088381	NLE3SESELU	EURO LEGEND ARROW UP FOR NLE3SES
1051088382	NLE3SESELLR	EURO LEGEND ARROW L/R FOR NLE3SES
1051088383	NLE3SESILU	ISO 7010 EURO LEGEND ARROW UP FOR NLE3SES
1051088384	NLE3SESILLR	ISO 7010 EURO LEGEND ARROW L/R FOR NLE3SES
1051088385	NLE3SESILD	ISO 7010 EURO LEGEND ARROW DOWN FOR NLE3SES

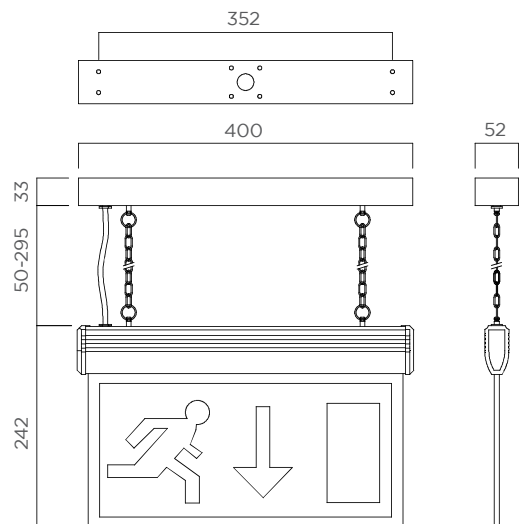

LED Emergency Wall Exit Box

A slim and stylish LED exit sign with a range of legends.



No re-lamping or maintenance required for lifetime of the fitting



Can be installed in maintained switchable, maintained non-switchable and non-maintained mode



Supplied with euro down legend fitted. Up and Left/Right legends are also supplied loose in the packaging



Maximum viewing distance of 30m



Order No.	Model No.	Description	Wattage (W)
1051088386	NLE3WES	5W LED M/NM EMERGENCY WALL EXIT BOX C/W EURO LEGENDS	5

Accessories

1051088387	NLE3WESILU	ISO 7010 LEGEND ARROW UP FOR NLE3WES
1051088388	NLE3WESILD	ISO 7010 LEGEND ARROW DOWN FOR NLE3WES
1051088389	NLE3WESILLR	ISO 7010 LEGEND ARROW L/R FOR NLE3WES

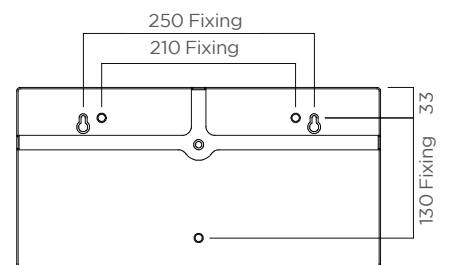
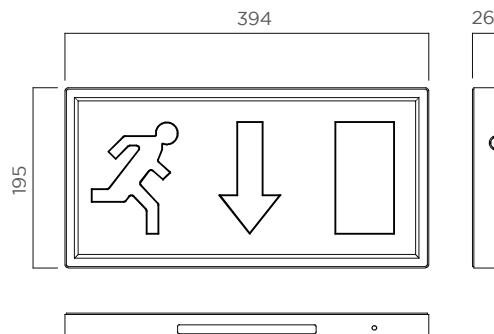



Arlington Pro

Versatile LED exit sign with drop blade for multitude of fixing options, for 3-hour maintained or non-maintained operation.



Material construction

- Injection moulded white polycarbonate body
- 5mm thick clear acrylic blade
- Changeable 0.25mm thick acrylic screen printed exit legends



Suitable for direct fix on ceiling, wall or via vertical conduit mounting



Optional legends & mounting accessories (Recessed, Wire Suspension & Side Wall)



Lithium iron phosphate (LiFePO4) battery technology



Order No.	Model No.	Description	Wattage (W)	Colour Temperature (K)
2501393711	NAL/M3	ARLINGTON PRO LED MAINTAINED 3HR BLADE EXIT SIGN	2	6500
2501309062	NAL/STM3	ARLINGTON PRO LED MAINTAINED 3HR BLADE EXIT SIGN SELF TEST	2	6500

Accessories

2501219167	NAL/RMK	ARLINGTON PRO RECESSED MOUNTING KIT
2501219168	NAL/SWMK	ARLINGTON PRO SIDE WALL MOUNTING KIT
2501219169	NAL/WSK	ARLINGTON PRO WIRE SUSPENSION KIT
2501219165	NAL/LE/UP	ARLINGTON PRO EURO LEGEND RUNNING MAN UP PACK
2501219163	NAL/LE/LR	ARLINGTON PRO EURO LEGEND RUNNING MAN LEFT RIGHT PACK
2501219166	NAL/LE/UP/V2	ARLINGTON PRO V2 ISO LEGEND MAN RUNNING THRU DOOR UP PACK
2501219164	NAL/LE/LR/V2	ARLINGTON PRO V2 ISO LEGEND MAN RUNNING THRU DOOR LEFT RIGHT PACK
2501219162	NAL/LE/DOWN/V2	ARLINGTON PRO V2 ISO LEGEND MAN RUNNING THRU DOOR DOWN PACK



HEAD POSITIONED SO IT CAN BE MOUNTED TO THE CEILING



HEAD ROTATED 90° SO IT CAN BE MOUNTED TO A WALL

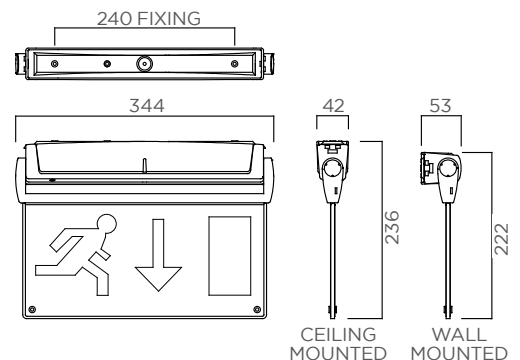

REXEL LIGHTING SOLUTIONS

EXPERTS IN ALL AREAS OF LIGHTING AND LIGHTING CONTROL



Whatever your needs, we stock and source all types of lamps and lighting including more specialist products: lamps, luminaires, control gear, LED drivers and many other hard to source products.

We also stock and can source a huge range of fuses and heating spares, so you can count on our expertise to get what you need to get the job done...and fast!



Contact your local branch or go to rexel.co.uk

EXPERTISE TRAINING SURVEYS DESIGN SOLUTIONS

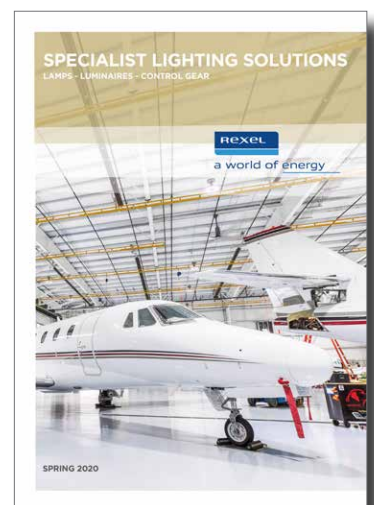

a world of energy

REXEL.CO.UK

CONTACT US: lighting.solutions@rexel.co.uk

LED Emergency Escape Route

A recessed mounted emergency LED which avoids the need for unsightly surface bulkheads.

- ✓ Lithium Ion Phosphate (LiFePO4) battery
- FIT + FORGET** Non-Maintained operation with a momentary test button fitted
- ✓ Changeable lens that offers both wide and oval light distribution
- ✓ Small discreet emergency luminaire
- 🏠 Up to 50% saving versus Nickel cadmium (NiCd) batteries





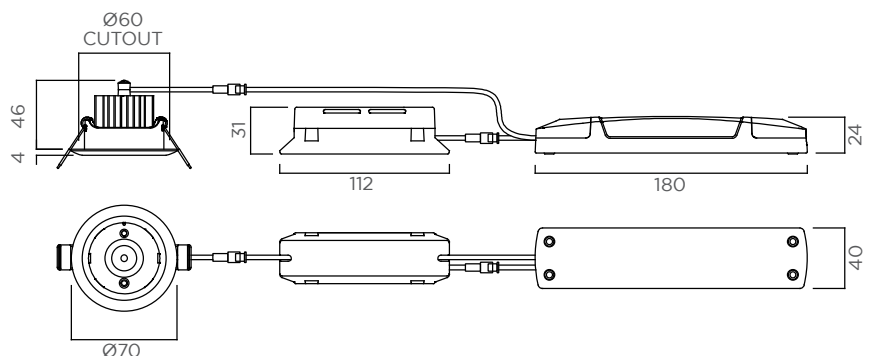

Order No.	Model No.	Description	Wattage (W)
2501312166	NSC3/REC/NM3	LED ESCAPE ROUTE DOWNLIGHT NON-MAIN	3
2501312167	NSC3/REC/STNM3	LED ESCAPE ROUTE DOWNLIGHT NON-MAIN SELFTEST	3



LED Emergency Twinspot

A range of emergency twinspots with twin heads that can rotate and tilt. The fitting can also be mounted in any orientation for flexibility during installation. Suitable for general emergency lighting applications in commercial and industrial use.

-  Injection moulded ABS body
-  Polycarbonate heads, including lens
-  Push fit terminal block for quick and simple installation
-  IP65 or IP20 option available
-  3 hour non-maintained



Order No.	Model No.	Description	Wattage (W)
1051088392	NLE3TS	2 X 3 W LED NON MAINTAINED SELF TEST TWINSPOT	6
2501182970	NKS2X3/IP20/NM3	2 X 3 W LED NON -MAINTAINED TWINSPOT	6

IP20

RXL-NKS2X3/IP20/NM3

IP65

NLE3TS

5

YEAR WARRANTY

50,000 HOURS

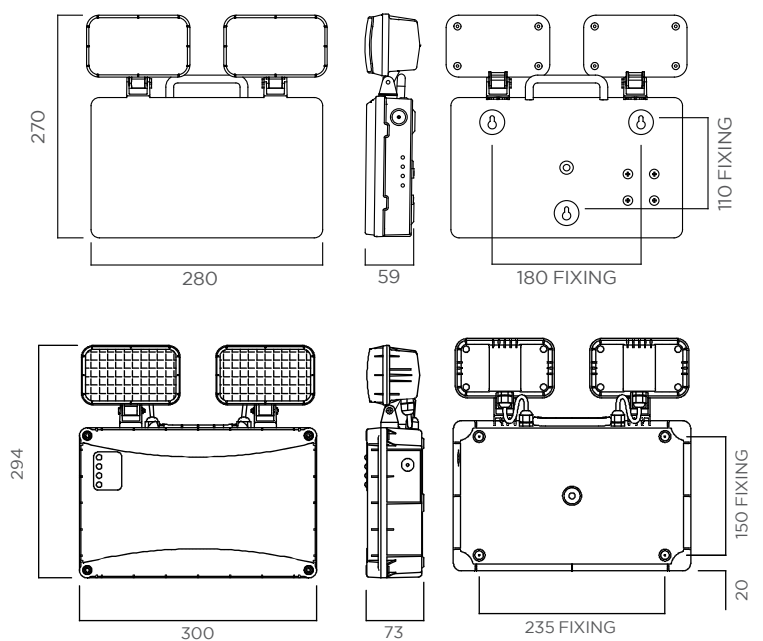

RoundTech



RoundTech, Medium Recessed, Safety Escape Route & Safety Open Area optical choice, Low bay (Up to 9M), 200 lumens in Emergency Mode, Maintained / Non-Maintained, Stand Alone & with Manual Test, 3hr duration, IP65.



Material Construction

- Polycarbonate, White RAL9003



Maintained / Non-Maintained, Stand Alone, Auto test & with Manual Test



LED self-contained safety luminaire



Easy recessed installation via standard hole saw (Ø 64-78mm)



Escape route or open area optics - selectable on the fitting



Order No.	Model No.	Description	Lumens (lm)	Colour Temperature (K)
2501385977	RT2RSO150SA3H	MEDIUM RECESSED, SAFETY OPEN AREA, NON-MAIN, STAND ALONE, IP44	200	5700
2501385978	RT2RSEO200STF3HIP	MEDIUM RECESSED, SAFETY ESCAPE ROUTE & SAFETY OPEN AREA OPTICAL CHOICE, IP65	200	5700
2501385979	RT2RSEO200ATF3HIP	MEDIUM RECESSED, SAFETY ESCAPE ROUTE & SAFETY OPEN AREA OPTICAL CHOICE, AUTOTEST, IP65.	200	5700
2501385982	RT2RSEO200CGL3HIP	MEDIUM RECESSED, SAFETY ESCAPE ROUTE & SAFETY OPEN AREA OPTICAL CHOICE, CGLINE+ IP65.	200	5700
2501385983	RT2RSEO200DMP3HIP	MEDIUM RECESSED, SAFETY ESCAPE ROUTE & SAFETY OPEN AREA OPTICAL CHOICE, DALI IP65.	200	5700
2501385984	RT2EC4ICGL3	MEDIUM RECESSED, EXIT SIGN CEILING 2 SIDED, 4 NON-ADHESIVE EXIT LEGENDS (D,U,R,L & BLANK) ISO FORMAT,	200	5700
2501385980	RT2RHIEO200CGL3HIP	MEDIUM RECESSED, SAFETY ESCAPE ROUTE & SAFETY OPEN AREA OPTICAL CHOICE, CGLINE+ IP65.	200	5700

Accessories

2501388066	RT2R-RP	MEDIUM SIZE, RECESSED, RENOVATION PLATE
------------	---------	---



Flexitech

FlexiTech ED is a one-box solution that has unique dual mounting base, and a host of other clever features that ensures everything needed for easy install is in one-box!

Either single or double-sided, wall or ceiling mounted and whatever the arrow direction, FlexiTech ED will meet all your expectations without additional accessories. Homogenized illumination of the pictogram and Increased Affordance optional functionality will make the exit sign more visible and allow safer evacuation.

The use of LEDs, long life components, automatic testing and monitoring devices (CGLine+) significantly reduce the operating and maintenance costs of the installation.



Material Construction

- Polycarbonate, White RAL9003



Wall and ceiling mountable in one box, with its dual mounting base



Large working space, cable entries in flexible material and spirit level for easy and fast installation



20m viewing distance Exit sign, single and double sided



LED self-contained luminaire with Automatic Test (AT) for reduced inspection effort



Non obtrusive design and slim housing (34mm)



100,000 Hour rated life with 80% lumen maintenance



Order No.	Model No.	Description	Lumens (lm)
2501385999	FT2ED4IATL18	FLEXITECH EXIT SIGN AUTOTEST, SELECTABLE DURATION OF 1-8HR, STAND ALONE, 4 NON-ADHESIVE EXIT LEGENDS (D,U,R,L) ISO FORMAT, IP43	200
2501386000	FT2ED4ICGL18	FLEXITECH EXIT SIGN, CGLINE+, SELECTABLE DURATION OF 1-8HR, STAND ALONE, 4 NON-ADHESIVE EXIT LEGENDS (D,U,R,L) ISO FORMAT, IP43	200
2501386001	FT2SE400ATL18IP	FLEXITECH SAFETY LUMINAIRE, ESCAPE ROUTE OPTIC, MAINTAINED / NON-MAINTAINED, STAND ALONE, AUTOTEST, SELECTABLE DURATION OF 1-8HR, IP65	200
2501386002	FT2SE600CGL13IP	FLEXITECH SAFETY LUMINAIRE, ESCAPE ROUTE OPTIC, MAINTAINED / NON-MAINTAINED, STAND ALONE, CGLINE+, SELECTABLE DURATION OF 1-8HR, IP65	200



NexiLite/Nexitech LED

The modern style, the simplicity of the shapes and the high-quality surfaces make NexiTech LED ideal for any architectural context, while the precision of the mechanics and the sophisticated electronics guarantee a full unmatched reliability. The latest generation of LED light source provides a good and uniform light distribution.

The wide range of accessories allows installation on a wall or ceiling, surface or recessed in indoor and harsh environments, thanks to the IP65 protection kit. It is also possible to use it as a single or double-sided exit sign and to combine exit and safety lighting functions in one product.

The use of LEDs, automatic testing and monitoring devices (CGLine+) significantly reduce the operating and maintenance costs of the installation.



Material Construction

- Polycarbonate, White
- Diffuser clear polycarbonate
- Wall and ceiling mounting
- Surface or recessed installation in false ceiling and bricks wall



Bulkhead, Single Sided & Double Sided Exit signs in IP40 & IP65 options



Safety antipanic lighting and escape route lighting



Single side glue-less ISO7010 pictograms with 20M viewing distance/Double sided ISO7010 panels with 30M viewing distance



3H duration



Maintained and Non-Maintained mode on all version



Order No.	Model No.	Description	Lumens (lm)
2501140510	NXL250-3H	NEXILITE 250LM 3H MAINTAINED/NON-MAINTAINED	250
2501140524	NEXI250-3-AT	NEXITECH LED 250 3H AUTO TEST	250

Accessories

2501140514	NEXI-PICTO-D	EXIT LEGEND FOR NEXITECH DOWN
2501140515	NEXI-PICTO-L	EXIT LEGEND FOR NEXITECH LEFT
2501140516	NEXI-PICTO-R	EXIT LEGEND FOR NEXITECH RIGHT
2501140517	NEXI-PICTO-U	EXIT LEGEND FOR NEXITECH UP
2501140523	NEXI-FR	NEXI FINISHING FRAME FOR NEXITECH LED
2501140519	NEXI-IP	NEXI LED IP65 KIT
2501385997	NEXI-WB45	45° WALL BASE NEXITECH LED / NEXILITE (IP40/IP65)



BeamLite II

BeamLite II, high-intensity double light sources, provide efficient illumination of long, narrow escape routes, but can also provide general wide coverage of a specific area when positioned at any degree specified to each other, in locations where higher illumination is required. Also provides a complete solution from a single luminaire, whether you are providing lighting for a large factory floor, a shopping centre or an entertainment venue.

Rated at IP65 ingress protection and with IK07 impact resistance, BeamLite II can be used in even the harshest of environments while the new design, with compact efficient batteries and LED light heads contained in the same unit, also makes these emergency light fittings applicable for commercial applications.

This range of beam light self-contained luminaires is composed of 200 to 800lm light output. The LEDs within the BeamLite alongside the automatic testing and monitoring devices (using CGLine+ versions) significantly reduces the operating and maintenance costs of the installation.



Material Construction

- White RAL9003
- Polycarbonate (850 °C glow wire resistant)
- Surface mounted



Escape route or open area optics - selectable on the fitting



Locking mechanism of light head preventing accidental change of light heads configuration



Variants of 200lm, 400lm and 800lm light output



3H duration



Non-Maintained/Stand Alone



Order No.	Model No.	Description	Lumens (lm)
2501266979	BL2MD-C3UK	PROJECTOR HEAD LUMINAIRE, NARROW BEAM, 2 X 200 LUMENS IN EMERGENCY MODE, IP20	400
2501266990	BL2MC-A3	PROJECTOR HEAD LUMINAIRE, NARROW BEAM OR WIDE BEAM SELECTABLE, 2 X 100 LUMENS IN EMERGENCY MODE, IP65	200
2501266989	BL2MD-E3	NARROW BEAM OR WIDE BEAM SELECTABLE, 2 X 400 LUMENS IN EMERGENCY MODE, IP65	800
2501266992	BL2MD-C3-AT	NARROW BEAM OR WIDE BEAM SELECTABLE, 2 X 200 LUMENS IN EMERGENCY MODE, AUTO TEST, IP65	400
2501266991	BL2MC-A3CGL	NARROW BEAM OR WIDE BEAM SELECTABLE, 2 X 100 LUMENS IN EMERGENCY MODE, CGLINE+, IP65	200
2501266994	BL2MDC3DL	NARROW BEAM OR WIDE BEAM SELECTABLE, 2 X 200 LUMENS IN EMERGENCY MODE, DALI, IP65	400
2501266993	BL2MD-C3CGL	NARROW BEAM OR WIDE BEAM SELECTABLE, 2 X 200 LUMENS IN EMERGENCY MODE, CGLINE+, IP65	400
2501266995	BL2MD-E3CGL	NARROW BEAM OR WIDE BEAM SELECTABLE, 2 X 400 LUMENS IN EMERGENCY MODE, +, IP65	800



Zeta 4



The aesthetics have been enhanced to create a more modern and discreet appearance which is suitable for most project applications. By utilising the latest LED technology, the result is increased spacing performance while still maintaining low energy usage. Zeta 4 is suitable for use as an Escape route and open area luminaire, while providing extra versatility as an exit sign via the application of an optional adhesive legend kit.



Material Construction

- Polycarbonate - white RAL 9003
- Battery NiCd



Bulkhead, Single Sided and Double Sided Exit options



Surface ceiling or wall mount



Cable entry to top, bottom and rear



Emergency 3 hour



Order No.	Model No.	Description	Lumens (lm)
2501094465	ZE42ML3	(ESCAPE ROUTE, OPEN AREA OR EXIT SIGNAGE), MAINTAINED / NON-MAINTAINED, STAND ALONE, IP42 & IP65 WITH KIT INCLUDED	150
2501094467	ZE43ML3	LARGE SIZE, (ESCAPE ROUTE, OPEN AREA OR EXIT SIGNAGE), MAINTAINED / NON-MAINTAINED, STAND ALONE, IP42 & IP65 WITH KIT INCLUDED.	150

Accessories

2501143488	ZE42LEG	20M VIEWING DISTANCE (SMALL) EURO LEGEND KIT
2501094464	ZE42LEG-ISO	20M VIEWING DISTANCE (SMALL) SO7010
2501094463	ZE42DB	ZETA 4 (SMALL), 20M VIEWING DISTANCE DOUBLE SIDED CONE DIFFUSER
2501143489	ZE43LEG	30M VIEWING DISTANCE (LARGE) EURO LEGEND KIT
2501094469	ZE43LEG-ISO	30M VIEWING DISTANCE (LARGE) ISO7010 LEGEND KIT
2501094468	ZE43DB	ZETA 4 (LARGE), 30M VIEWING DISTANCE DOUBLE SIDED CONE DIFFUSER



INDUSTRIAL KNOW-HOW

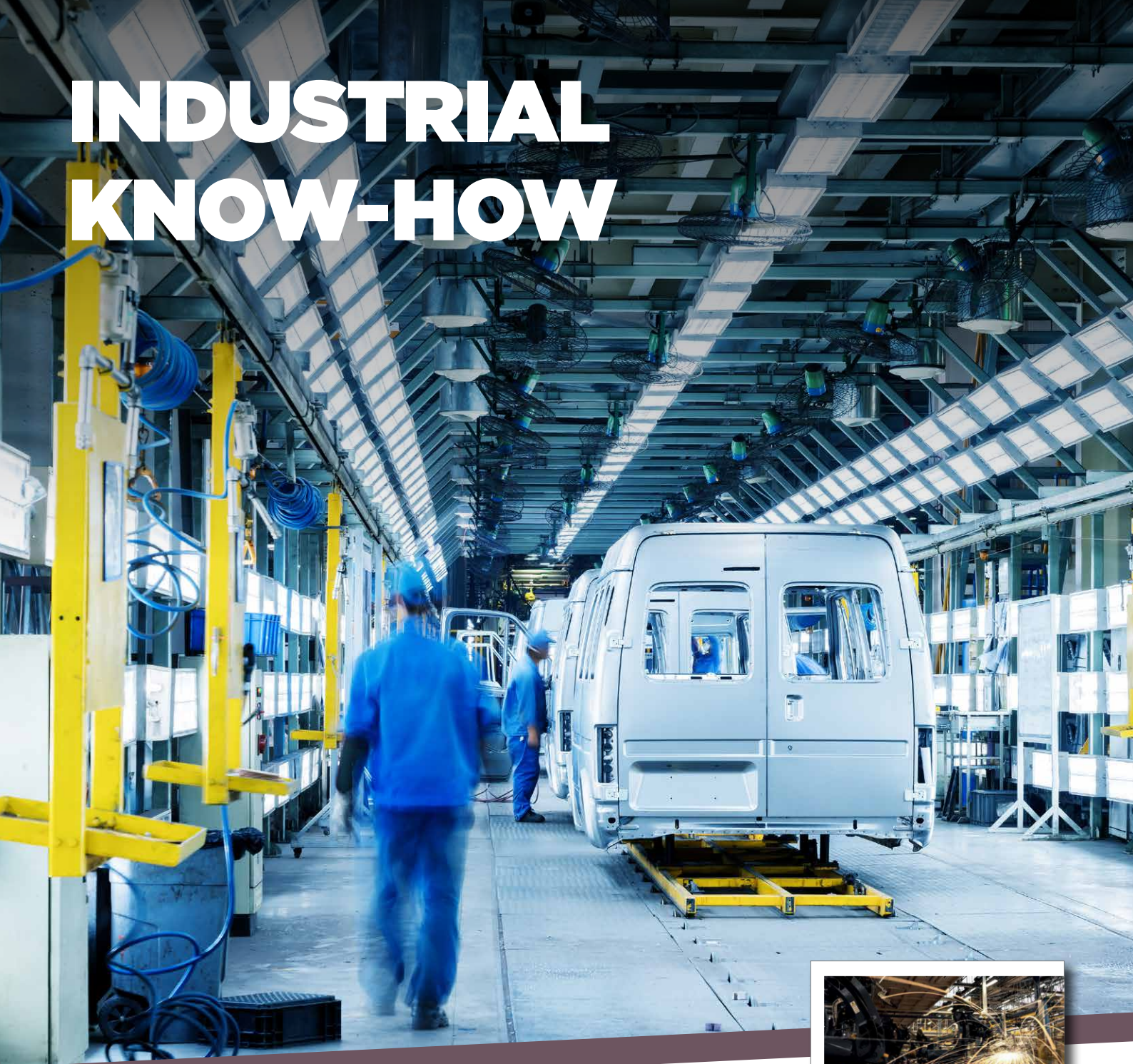

Our specialist Industrial Solutions team and dedicated industrial branches have the know-how to manage your single and multi-site locations with all the parts you need, and fast. Whether you require product or automation solutions we have the technical expertise. We also offer lighting design, energy surveys, stock and asset management and so much more in added value services - rely on us to keep you running!

Contact your local branch or go to rexel.co.uk

EXPERTISE DESIGN SURVEYS REPAIRS

INDUSTRIAL CONTACT CENTRE

Tel: 0333 400 5938

Email: industrial.enquiries@rexel.co.uk

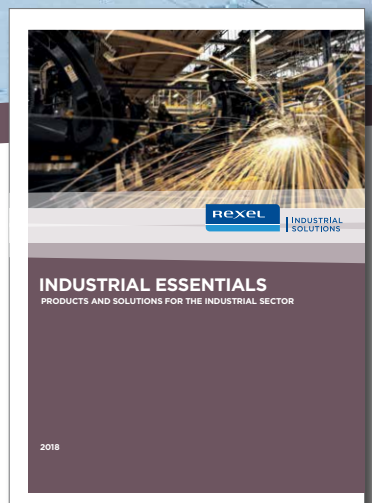

Industrial Lighting



LED Batten

A range of LED batten luminaires, ideal for new installations and retrofit in industrial, commercial and retail applications.



Material construction

- Steel body - white RAL 9003
- Opal polycarbonate diffuser - TP(B) rated
- Polycarbonate end caps



Suitable for direct fix, trunking and conduit mounting



Push wire terminals for plug and play installation



Emergency 3 hour options available



Order No.	Model No.	Description	Emergency	Wattage (W)	Lumens (lm)	Efficacy (Lm/W)	Colour Temperature (K)
2501182908	KSR9840	4FT LED SINGLE		23	2760	120	4000
2501182909	KSR9840/EM	4FT LED SINGLE	Y	23	2760	120	4000
2501182910	KSR9841	4FT LED TWIN		40	4800	120	4000
2501182911	KSR9841/EM	4FT LED TWIN	Y	40	4800	120	4000
2501182912	KSR9842	5FT LED SINGLE		38	4560	120	4000
2501182913	KSR9842/EM	5FT LED SINGLE	Y	38	4560	120	4000
2501182914	KSR9843	5FT LED TWIN		60	7200	120	4000
2501182915	KSR9843/EM	5FT LED TWIN	Y	60	7200	120	4000
2501182916	KSR9844	6FT LED SINGLE		48	5760	120	4000
2501182917	KSR9844/EM	6FT LED SINGLE	Y	48	5760	120	4000
2501182918	KSR9845	6FT LED TWIN		65	7800	120	4000
2501182919	KSR9845/EM	6FT LED TWIN	Y	65	7800	120	4000

5
YEAR
WARRANTY

IP20

IK08

CLASS
1

L70
35,000
HOURS

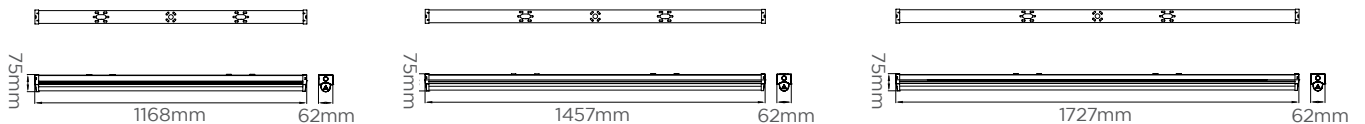



Poppy LED Batten

Calm and composed, Poppy blends into a wide range of indoor settings. Ideal for corridors, warehouses, and workshops



Material Construction

- Body: sheet metal, white finish (RAL 9002)
- Diffuser: polycarbonate, opal
- End caps: polycarbonate, white (RAL 9002)



An easy to install and versatile IP20 batten



Homogeneous illumination



Quick opening and installation thanks to the press release buttons



Order No.	Model No.	Description	Emergency	Wattage (W)	Lumens (lm)	Efficacy (Lm/W)	Colour Temperature (K)
2501145880	96631258	POPPY LED 1200MM 2500 840		24	2500	104	4000K
2501145881	96631268	POPPY LED 1200MM 2500 840	YES	24	2500	104	4000K
2501145884	96631259	POPPY LED 1200MM 5000 840		48	5000	104	4000K
2501145885	96631269	POPPY LED 1200MM 5000 840	YES	48	5000	104	4000K
2501145882	96631260	POPPY LED 1500MM 4500 840		40	4504	113	4000K
2501145883	96631270	POPPY LED 1500MM 4500 840	YES	40	4504	113	4000K
2501145886	96631261	POPPY LED 1500MM 6500 840		60	6500	108	4000K
2501145888	96631271	POPPY LED 1500MM 6500 840	YES	60	6500	108	4000K
2501145887	96631262	POPPY LED 1800MM 6500 840		60	6500	108	4000K
2501145890	96631272	POPPY LED 1800MM 6500 840	YES	60	6500	108	4000K
2501145891	96631263	POPPY LED 1800MM 8500 840		80	8508	106	4000K
2501145892	96631273	POPPY LED 1800MM 8500 840	YES	80	8508	106	4000K

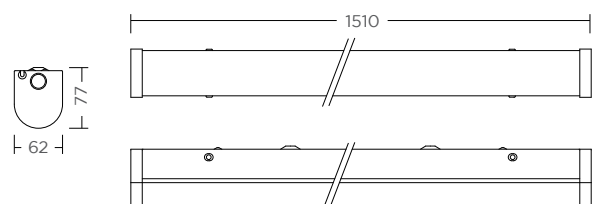



Batten for LED Tubes

The Powerlite Fitzgerald LED ready batten is a high quality product made in the UK, manufactured from mild steel and supplied with Polycarbonate lampholders, designed for LED tubes wired at both ends.



Material Construction

- Steel body - white Resilient finish
- Opal polycarbonate
- diffuser - TP(B) rated
- Polycarbonate end caps



Suitable for direct fix, trunking and conduit mounting



Push wire terminals for plug and play installation



Emergency 3 hour options available



Tube not included



Order No.	Model No.	Description
2501355958	LP136/40/NS/NC/X	4FT SINGLE LED READY
2501355959	LP158/65/NS/NC/X	5FT SINGLE LED READY
2501355960	LP170/75/NS/NC/X	6FT SINGLE LED READY
2501355961	LPT236/40/NS/NC/X	4FT DOUBLE LED READY
2501355962	LPT258/65/NS/NC/X	5FT DOUBLE LED READY
2501355963	LPT270/75/NS/NC/X	6FT DOUBLE LED READY

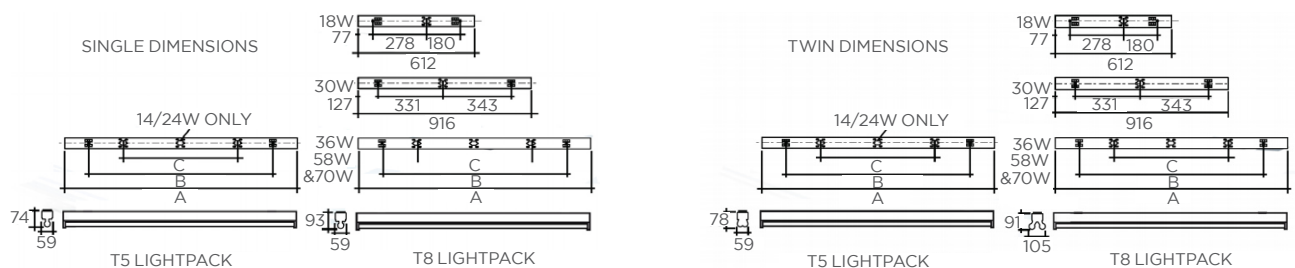

LED Non-corrosive

An LED equivalent to 4ft, 5ft and 6ft fluorescent non corrosive luminaires, ideal for new and retrofit applications. A robust solution for a variety of indoor, high humidity, under canopy applications.



Material construction

- Polycarbonate- Grey Pantone 427C
- Opal polycarbonate
- Stainless steel clips



Suitable for Chain/Wire suspension



Anti tamper diffuser clips for added security



Emergency 3 hour options available



Order No.	Model No.	Description	Emergency	Wattage (W)	Lumens (lm)	Efficacy (Lm/W)	Colour Temperature (K)
2501182971	NCV1X4/840	4FT LED SINGLE		24	2715	113	4000
2501182972	NCV1X4/M3/840	4FT LED SINGLE	Y	24	2715	113	4000
2501182973	NCV2X4/840	4FT LED TWIN		40	4600	115	4000
2501182974	NCV2X4/M3/840	4FT LED TWIN	Y	40	4600	115	4000
2501182975	NCV1X5/840	5FT LED SINGLE		35	3875	111	4000
2501182976	NCV1X5/M3/840	5FT LED SINGLE	Y	35	3875	111	4000
2501182977	NCV2X5/840	5FT LED TWIN		57	6600	116	4000
2501182978	NCV2X5/M3/840	5FT LED TWIN	Y	57	6600	116	4000
2501182979	NCV1X6/840	6FT LED SINGLE		46	5060	110	4000
2501182980	NCV1X6/M3/840	6FT LED SINGLE	Y	46	5060	110	4000
2501182981	NCV2X6/840	6FT LED TWIN		74	8436	114	4000
2501182982	NCV2X6/M3/840	6FT LED TWIN	Y	74	8436	114	4000

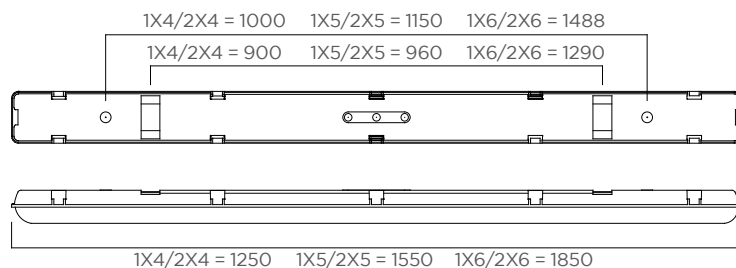
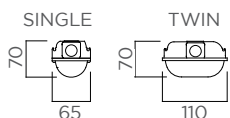



Julie LED Non-corrosive

With a tough exterior, Julie is the optimal choice for industrial and commercial applications. Ideal for underpasses, car parks, warehouses and workshops.



Material Construction

- Canopy: Polycarbonate
- Diffuser: Opal polycarbonate (UV stabilised)
- Bracket: Stainless steel



High quality, low energy lighting in wet and dusty environments



Versions with presence sensor and corridor function



High quality opal diffuser for uniform lighting



Order No.	Model No.	Description	Version	Wattage (W)	Lumens (lm)	Efficacy (Lm/W)	Colour Temperature (K)
2500980608	96628548	JULIE 600 LED IP65		19	2200	116	4000K
2500931091	96665577	JULIE 1200 LED IP65		38	4200	111	4000K
2501095965	96630234	JULIE 1200 LED IP65 COR MWS	PRESENCE & CORRIDOR	38	4200	111	4000K
2500931094	96665579	JULIE 1200 LED IP65	EMERGENCY	38	4200	111	4000K
2500931092	96628396	JULIE 1500 LED IP65		38	4200	111	4000K
2501095966	96630235	JULIE 1500 LED IP65 COR MWS	PRESENCE & CORRIDOR	38	4200	111	4000K
2500931095	96628397	JULIE 1500 LED IP65	EMERGENCY	38	4200	111	4000K
2500931093	96665580	JULIE 1500 LED IP65		55	6300	115	4000K
2501095968	96630236	JULIE 1500 LED IP65 COR MWS	PRESENCE & CORRIDOR	55	6300	115	4000K
2500931096	96665582	JULIE 1500 LED IP65	EMERGENCY	55	6300	115	4000K
2501139807	96631143	JULIE 1800 LED IP65		76	8600	113	4000K
2501139808	96631144	JULIE 1800 LED IP65	EMERGENCY	76	8600	113	4000K

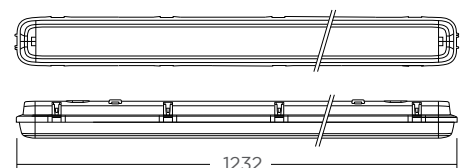
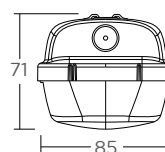

LED Highbay

An ultra efficient conventional LED highbay. With a large heatsink for reducing thermal stress on the LEDs ensuring long rated life and efficacy. Staggering 150lm/W performance with multiple lumen outputs to make this a perfect replacement for existing 150W, 250W, 400W & 600W HID installations. Now in fully recyclable packaging.



Material construction

- Large die cast aluminium heatsink
- Clear polycarbonate diffuser



Suitable for suspension mounting and supplied with safety cable



Pre-wired with 2m mains and 1-10V dimming flex cables



150lm/W to give rapid ROI



Bespoke 6W emergency inline POD for 1000lm output available



Reflectors available



Order No.	Model No.	Description	Wattage (W)	Lumens (lm)	Efficacy (Lm/W)	Colour Temperature (K)
2501401793	RXL-IND165V3-C10	87W LED HIGHBAY	87	13000	150	4000
2501401794	RXL-IND166V3-C10	130W LED HIGHBAY	130	19500	150	4000
2501401795	RXL-IND167V3-C10	175W LED HIGHBAY	175	26000	150	4000
2501424931	RXL-IND215V3-C10	240W LED HIGHBAY	240	39000	150	4000

Accessories

2501401796	ACS137	60D ALUMINIUM REFLECTOR FOR HIGHBAY
2501401797	ACS138	90D ALUMINIUM REFLECTOR FOR HIGHBAY
2501230297	ACS141	ROTATABLE BRACKET
2501230368	EMG024	6W EMERGENCY REMOTE PACK



RXL-IND165-C10/166V3-C10

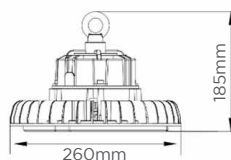

RXL-IND167V3-C10

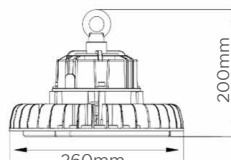

RXL-IND215V3-C10

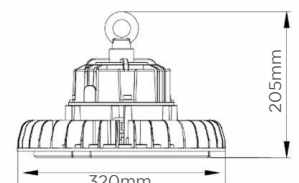

LED Lowbay

The slim Lowbay has the LED chambers mounted separately to aid in thermal management and LED performance. This boosted performance results in remarkable rated life benefits. Achieving 90% lumen maintenance at the rated life of 50,000Hrs this Lowbay yields massive energy savings compared with HID installations - Replacing existing 150W and 250W Metal Halide fittings. Commonly used in open areas such as assembly areas and manufacturing lines.



Material construction

- Steel body - White
- Opal polycarbonate diffusers



Suitable for suspension mounting with mounting hooks provided. Trunking mount accessory available.



Loop in - Loop Out terminals are easily accessible in centre of fitting - with central and end entry points



Emergency 3 hour options available



Order No.	Model No.	Description	Wattage (W)	Lumens (lm)	Efficacy (Lm/W)	Colour Temperature (K)
2501401798	RXL-IND240	100W LOBAY	100	14,500	145	4000
2501424929	RXL-IND240EM	100W LOBAY	100	14,500	145	4000
2501401799	RXL-IND241	135W LOBAY	135	18,900	140	4000
2501424930	RXL-IND241EM	135W LOBAY	135	18,900	140	4000

Accessories

2501401800	ACS214	TRUNKING MOUNTING BRACKETS (SET OF 2)
------------	--------	---------------------------------------

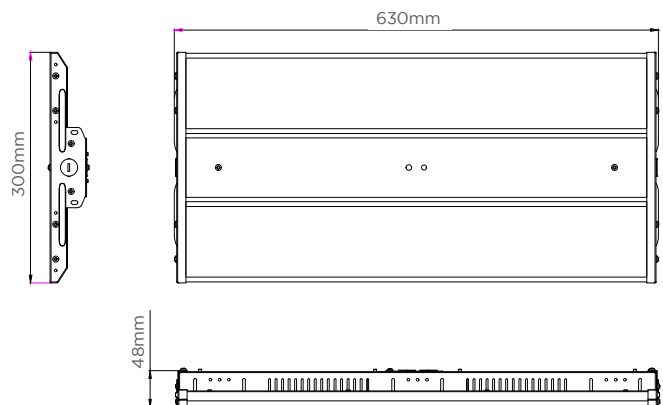

LED Midibay

The Midibay is designed to be the next generation of LED lighting for warehouse and industrial applications. Using the market leading Samsung 301B LEDs to achieve a staggering 155lm/W. Mixing the Samsung LED with long life Tridonic drivers this Midibay has a rated life >100,000 Hours in a wide operating ambient. Optional 90° prismatic refractor lowers glare and improves ground lux by up to 25%.



Material Construction

- Steel body - white RAL 9016
- Clear Polycarbonate diffuser



Supplied with eyebolts and trunking brackets for surface/suspension mounting



Supplied with 2m flex



Emergency 3 hour option available



Exceptional efficacy and return on investment



100,000 Hour rated life with 80% lumen maintenance



Wireguard accessory for sports hall applications



Order No.	Model No.	Description	Emergency	Wattage (W)	Lumens (lm)	Efficacy (Lm/W)	Colour Temperature (K)
2501360223	IND226	110W MIDIBAY EDGE PRO 2		110	17,050	155	5000
2501360233	IND226-EM	110W MIDIBAY EDGE PRO 2	YES	110	17,050	155	5000
2501360224	IND227	146W MIDIBAY EDGE PRO 2		146	22,630	155	5000
2501360246	IND227-EM	146W MIDIBAY EDGE PRO 2	YES	146	22,630	155	5000

Accessories

2501360181	ACS194	MIDIBAY WIRE GUARD					
------------	--------	--------------------	--	--	--	--	--

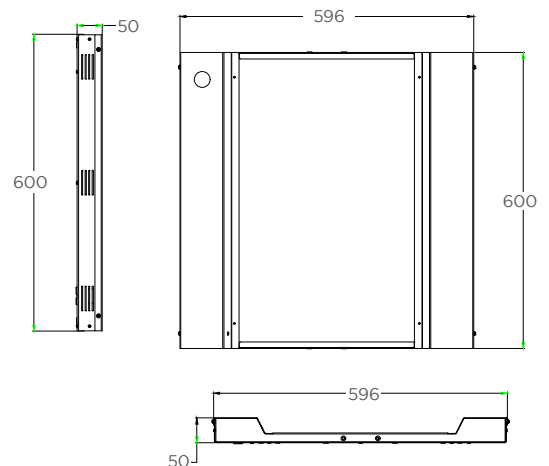

Industrial Lighting Project?



End to end support and expertise from Rexel Industrial Solutions

We offer a free of charge bespoke lighting service to help you to achieve the most creative, energy efficient and cost-effective solution for every industrial project

- Survey, advice and calculations – nationwide teams qualified to industry standards
- Design service - conform to the latest CIBSE/SLL guides & British standards
- Quality Products – all leading brands
- Installation via approved installers or supply only

Work in a better industrial light

Contact us for more information:

Email: Industrial.lighting@rexel.co.uk

REXEL

INDUSTRIAL
SOLUTIONS

Floodlights



LED Outdoor Floodlight

A range of floodlights ideal for residential security illumination.



Aluminium body, glass diffuser



Available with PIR option for added energy savings



Wide beam angle of 110°



Pre-wired with 0.75M of HO5RN-F rubber cable



Order No.	Model No.	Description	Wattage (W)	Lumens (lm)	Efficacy (Lm/W)	Colour Temperature (K)
2501120809	EFLD10B40	LED FLOODLIGHT	10	800	80	4000
2501120810	EFLD10B40P	LED FLOODLIGHT PIR	10	800	80	4000
2501120811	EFLD20B40	LED FLOODLIGHT	20	1600	80	4000
2501120812	EFLD20B40P	LED FLOODLIGHT PIR	20	1600	80	4000
2501120813	EFLD30B40	LED FLOODLIGHT	30	2400	80	4000
2501120814	EFLD30B40P	LED FLOODLIGHT PIR	30	2400	80	4000
2501120815	EFLD50B40	LED FLOODLIGHT	50	4000	80	4000
2501120816	EFLD50B40P	LED FLOODLIGHT PIR	50	4000	80	4000



PIR VERSIONS ARE IP54

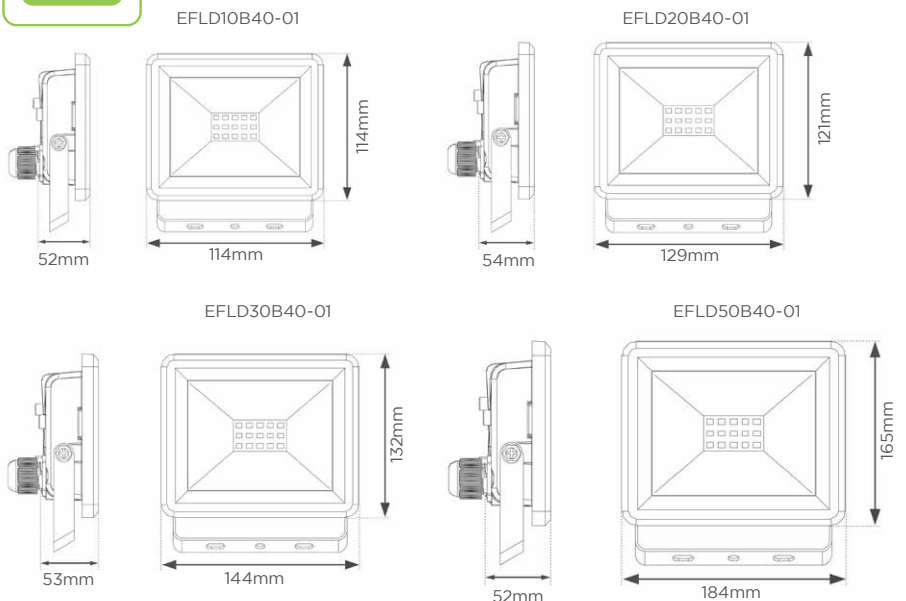

Need it tomorrow morning? Order by 5pm

Floodlight Sensor



IP65 Floodlights with flexible motion and daylight sensor.



Material Construction

- Aluminium Body
- Tempered Glass diffuser



Suitable for wall and ceiling mounting



IP65 adjustable sensor with manual "always on" override function



70,000 hr life (L70 B50)



IK08 No sensor option, IK07 Sensor option



Input voltage 100 -277 V AC



Prewired with 1mtr of (H05RN-F) cable for easy installation



Order No.	Model No.	Description	Sensor	Wattage (W)	Lumens (lm)	Efficacy (Lm/W)	Colour Temperature (K)
2501314898	4058075460874	FL PFM SYM 100 S BK	YES	10	1200	120	4000
2501120870	4058075460911	FL PFM SYM 100 S BK	YES	20	2200	110	3000
2501120871	4058075460959	FL PFM SYM 100 S BK	YES	20	2400	120	4000
2501120873	4058075461031	FL PFM SYM 100 S BK	YES	50	6000	120	4000
2501120875	4058075420885	FL PFM SYM 100 BK		10	1200	120	4000
2501120866	4058075421011	FL PFM SYM 100 BK		20	2400	120	4000
2501243161	4058075421134	FL PFM SYM 100 BK		30	3600	120	4000
2501120859	4058075421226	FL PFM SYM 100 BK		50	5500	110	3000
2501120745	4058075421264	FL PFM SYM 100 BK		50	6000	120	4000



4058075460874

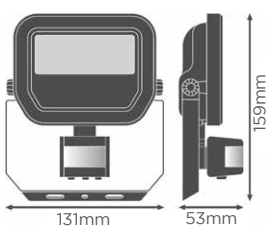

4058075460911

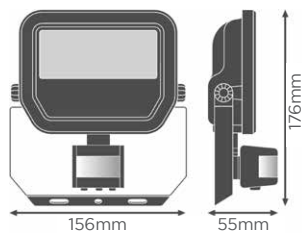

4058075460959

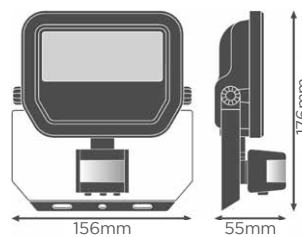

4058075461031

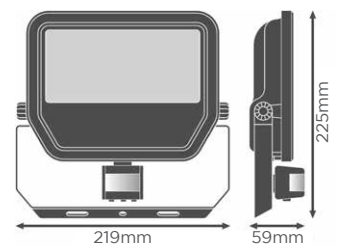

Commercial Lighting Project?

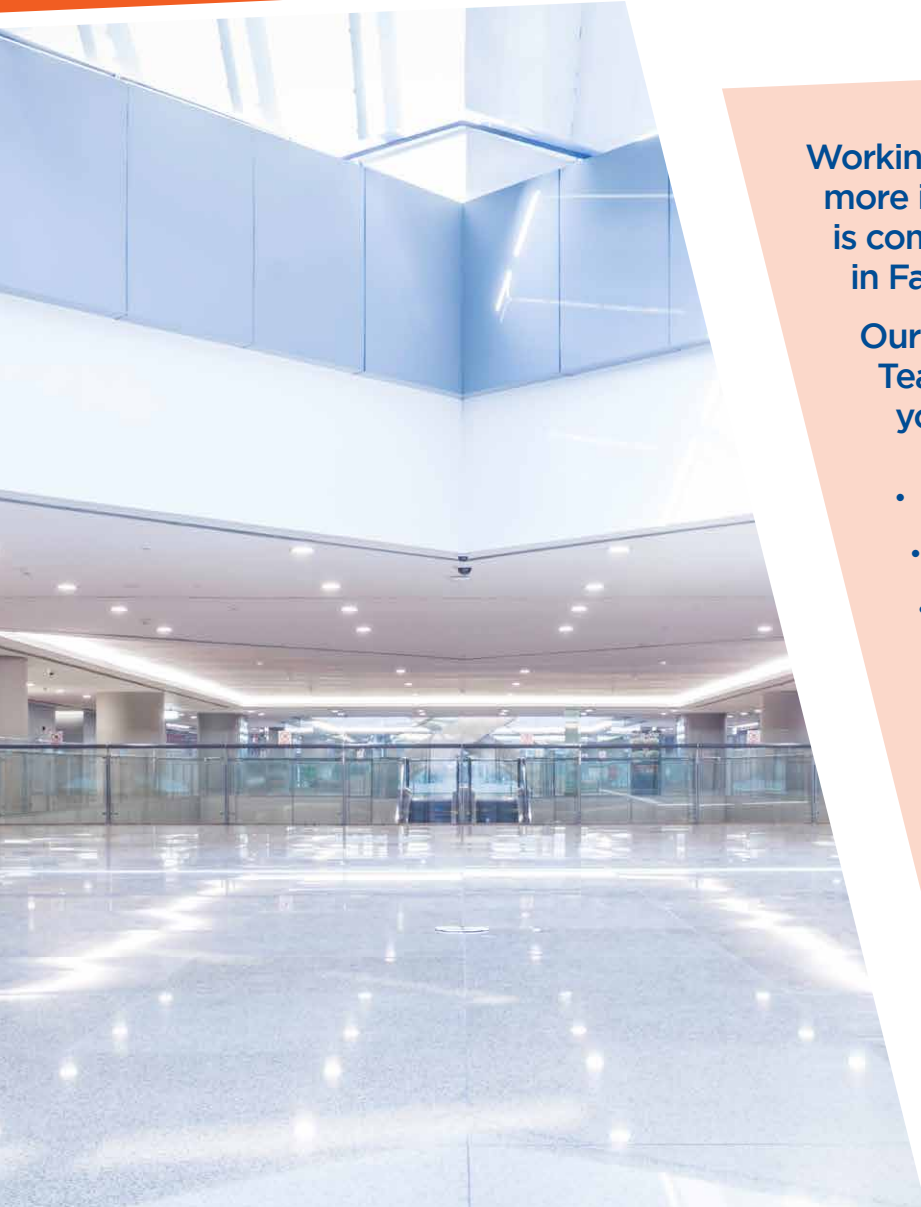

Working in a better light has never been more important, whether your project is commercial, public sector or you're in Facilities Management.

Our Lighting Design and Solutions Team has the expertise to advise you on every aspect:

- Wellbeing and safety of building users
- Recommendations for the building function
- Frequency of maintenance
- Energy and cost-savings
- Aesthetics / lighting design
- Control gear, spare parts and critical spares including specialist and obsolete products
- Consignment stock
- End to end project management (new and retro-fit)

Work in a better commercial light

Contact us for more info:

Find your local branch: [rexel.co.uk/store-finder](https://www.rexel.co.uk/store-finder)

FM customers

FM Contact Centre: 0330 045 0606 **Email:** customer.connect@rexel.co.uk



a world of energy

LED Outdoor Floodlight Commercial/Industrial

The industrial floodlight range is ideal for both industrial and commercial applications offering equivalents up to 250W SON/MH, whilst offering significant energy savings over discharge light fittings with a similar size and shape to traditional commercial floodlights, these are ideal for retrofit applications.



Materials

- Aluminium housing and body
- Glass diffuser



Mounting bracket for 180° tilt



Features a beam angle of 100°



Photocell option available to turn fitting off when there is enough natural daylight



Order No.	Model No.	Description	Photocell	Wattage (W)	Lumens (lm)	Efficacy (Lm/W)	Colour Temperature (K)
2501157628	4058075422469	LED COMMERCIAL FLOODLIGHT		65	7700	110	4000
2501157629	4058075461109	LED COMMERCIAL FLOODLIGHT	Y	65	7700	110	4000
2501157630	4058075422520	LED COMMERCIAL FLOODLIGHT		80	10000	125	4000
2501157631	4058075461147	LED COMMERCIAL FLOODLIGHT	Y	80	10000	125	4000
2501157632	4058075423701	LED COMMERCIAL FLOODLIGHT		125	15000	120	4000
2501157633	4058075461161	LED COMMERCIAL FLOODLIGHT	Y	125	15000	120	4000
2501157634	4058075423732	LED COMMERCIAL FLOODLIGHT		165	20000	121	4000
2501157635	4058075461185	LED COMMERCIAL FLOODLIGHT	Y	165	20000	121	4000

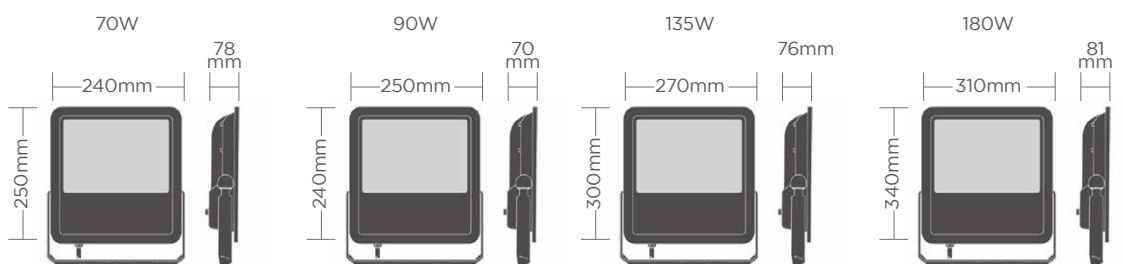

LED Commercial/Industrial Floodlight - Asymmetric

This industrial floodlight features an impressive 125 LPW efficacy in a compact and thermally efficient housing. Versatile mounting options make the Portland at home in any application and precise asymmetric light distribution ensures every lumen is placed exactly where you need it. This Floodlight is available with multiple beam angles, control and wattage options making it the ideal solution for professional lighting designs in Industrial and commercial applications.



Material Construction

- Die cast Aluminium body
- Tempered Glass Cover



Asymmetric beam angle as standard for optimal spread of light



Photocell options



Angled, adjustable bracket for ease of install



Pre-wired with 1.5m flying lead



100,000Hour rated life with 80% lumen maintenance after 85,000Hrs use



Order No.	Model No.	Description	Photocell	Wattage (W)	Lumens (lm)	Efficacy (Lm/W)	Colour Temperature (K)
2501360205	FLD150	50W PORTLAND FLOODLIGHT		50	6,250	125	4000
2501401099	FLD150-PM	50W PORTLAND FLOODLIGHT	YES	50	6,250	125	4000
2501360206	FLD151	100W PORTLAND FLOODLIGHT		100	12,500	125	4000
2501401100	FLD151-PM	100W PORTLAND FLOODLIGHT	YES	100	12,500	125	4000
2501360207	FLD152	150W PORTLAND FLOODLIGHT		150	18,750	125	4000
2501401101	FLD152-PM	150W PORTLAND FLOODLIGHT	YES	150	18,750	125	4000
2501360208	FLD153	200W PORTLAND FLOODLIGHT		200	25,000	125	4000
2501401102	FLD153-PM	200W PORTLAND FLOODLIGHT	YES	200	25,000	125	4000

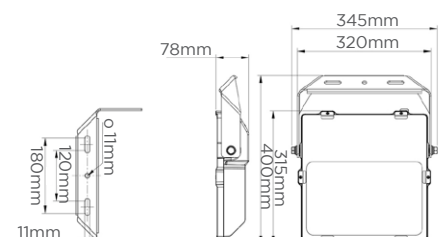

Amenity Lighting



Indoor Bulkhead

A commercial and residential LED bulkhead luminaire ideal for new installations and retrofit applications in areas such as bathrooms, utility areas, student accommodation and hotels. Supplied with a white bezel as standard, or chrome trim available separately. Emergency and Microwave sensor variants available.



Material construction

- Base - Polycarbonate
- Diffuser - Polycarbonate



Colour Temperature & Wattage selectable
3000K, 4000K, 6000K



Push Fit Terminals for Easy Installation



Suitable for Beza Box Mounting



Class II With Earth Provision as standard



Wall or ceiling mountable



Order No.	Model No.	Description	Emergency	Wattage (W)	Lumens (lm)	Colour Temperature	CRI
2501401801	KSRSF400	ROMA SELECT LED MULTI WATTAGE TRIPLE CCT SURFACE FITTING	N	10W	1067	3000K	85
				10W	1170	4000K	87
				10W	1125	6000K	84
				14W	1341	3000K	85
				14W	1526	4000K	87
				14W	1443	6000K	84
				20W	1719	3000K	85
				20W	1962	4000K	87
20W	1782	6000K	84				
2501401803	KSRSF401	ROMA SELECT LED MULTI WATTAGE TRIPLE CCT SURFACE FITTING WITH INTEGRAL EMERGENCY	Y	SEE ABOVE	SEE ABOVE	SEE ABOVE	SEE ABOVE
2501401804	KSRSF402	ROMA SELECT LED MULTI WATTAGE TRIPLE CCT SURFACE FITTING WITH MICROWAVE SENSOR	N	SEE ABOVE	SEE ABOVE	SEE ABOVE	SEE ABOVE
2501401805	KSRSF403	ROMA SELECT LED MULTI WATTAGE TRIPLE CCT SURFACE FITTING WITH MICROWAVE SENSOR AND INTEGRAL EMERGENCY	Y	SEE ABOVE	SEE ABOVE	SEE ABOVE	SEE ABOVE

Accessories

2501401810	KSRSF406	ROMA SELECT CHROME RIM
------------	----------	------------------------

5
YEAR
WARRANTY

IP65

IK10

L70
40,000
HOURS

CLASS
2

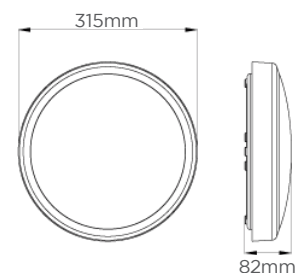

LED Residential Decorative Bulkhead

An LED bulkhead, ideal for bathrooms, utility and decorative installations. Easy installation with interchangeable twist on/off white and polished chrome bezels for classic or decorative finishes.



Material construction

- Polycarbonate body
- Opal polycarbonate diffuser



Wall and ceiling mountable



Push fit connector for quick and easy installation



Comes with white and chrome bezels in the box



Order No.	Model No.	Description	Wattage (W)	Lumens (lm)	Efficacy (Lm/W)	Colour Temperature (K)
2501003718	EBH22S40-02	RESIDENTIAL DECORATIVE BULKHEAD	14	1300	93	4000K
2501182969	EBH28S40-02	RESIDENTIAL DECORATIVE BULKHEAD	17	1650	97	4000K

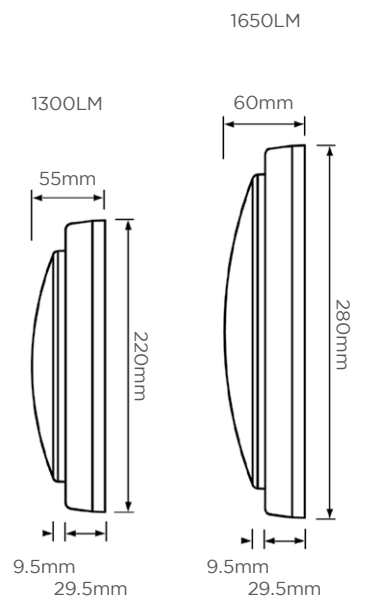

Outdoor Bulkhead

A commercial LED bulkhead luminaire ideal for new installations and retrofit applications in areas such as entrances, corridors, stairwells and other commercial areas. A range of accessories allow for a more decorative look yet maintaining its robust performance. Black and White rim options available in plain or eyelid styles.



Material construction

- Base - Polycarbonate
- Diffuser - Polycarbonate
- Rim - ABS



Colour Temperature & Wattage selectable
3000K, 4000K, 6000K



Push Fit Terminals for Easy Installation



Suitable for Beza Box Mounting



Class II With Earth Provision as standard



Multiple cable entries (Side or Rear) and
Suitable for Beza Bix Mounting



Order No.	Model No.	Description	Emergency	Wattage (W)	Lumens (lm)	Colour Temperature	CRI
2501401812	KSRSF330	NAVARA SF SELECT LED MULTI WATTAGE TRIPLE CCT SURFACE FITTING	N	10W	1145	3000K	85
				10W	1261	4000K	87
				10W	1212	6000K	84
				14W	1457	3000K	85
				14W	1658	4000K	87
				14W	1559	6000K	84
				20W	1819	3000K	85
				20W	2126	4000K	87
20W	1947	6000K	84				
2501401814	KSRSF331	NAVARA SF SELECT LED MULTI WATTAGE TRIPLE CCT SURFACE FITTING WITH INTEGRAL EMERGENCY	Y	SEE ABOVE	SEE ABOVE	SEE ABOVE	SEE ABOVE
2501401815	KSRSF332	NAVARA SF SELECT LED MULTI WATTAGE TRIPLE CCT SURFACE FITTING WITH MICROWAVE SENSOR	N	SEE ABOVE	SEE ABOVE	SEE ABOVE	SEE ABOVE
2501401816	KSRSF333	NAVARA SF SELECT LED MULTI WATTAGE TRIPLE CCT SURFACE FITTING WITH MICROWAVE SENSOR AND INTEGRAL EMERGENCY	Y	SEE ABOVE	SEE ABOVE	SEE ABOVE	SEE ABOVE

Accessories

2501401824	KSRSF323	PLAIN RIM MATT BLACK
2501401823	KSRSF324	PLAIN RIM MATT WHITE
2501401826	KSRSF325	EYELID RIM MATT BLACK
2501401825	KSRSF326	EYELID RIM MATT WHITE

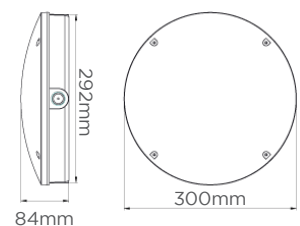

RadiaLED® Rapid - complete unit

Reviewing the channel and gaining valuable contractor feedback has become an essential requirement for JCC product development. RadiaLED® Rapid has been developed using feedback gathered from hundreds of electricians, providing strategic direction to create the most versatile and fastest to install product.



Material Construction

- Body: Polycarbonate
- Diffuser: Polycarbonate
- LED Tray: PA6 Nylon
- Rim: Polycarbonate



Designed with electricians, for electricians



Unique clip in tool-less LED gear tray design



Four side 20mm conduit entry points



Detachable loop-in/loop-out terminal block



8W Variants, small body 274mm.
12/16/24W Variants, large body 340mm



Order No.	Model No.	Description	Emergency	Wattage (W)	Lumens (lm)	Efficacy (Lm/W)	Colour Temperature (K)
2501348310	JC070065	RADIALED RAPID WITH WHITE RIM		8	760	95	4000
2501348311	JC070066	RADIALED RAPID EMERGENCY WITH WHITE RIM	YES	8	760	95	4000
2501348313	JC070075	RADIALED RAPID WITH WHITE RIM		12	1250	104	4000
2501348314	JC070076	RADIALED RAPID EMERGENCY WITH WHITE RIM	YES	12	1250	104	4000
2501348315	JC070079	RADIALED RAPID MICROWAVE ON/OFF WITH WHITE RIM		12	1250	104	4000
2501348316	JC070085	RADIALED RAPID WITH WHITE RIM		16	1600	100	4000
2501348317	JC070086	RADIALED RAPID EMERGENCY WITH WHITE RIM	YES	16	1600	100	4000
2501348318	JC070095	RADIALED RAPID WITH WHITE RIM		24	2160	90	4000
2501348319	JC070096	RADIALED RAPID EMERGENCY WITH WHITE RIM	YES	24	2160	90	4000

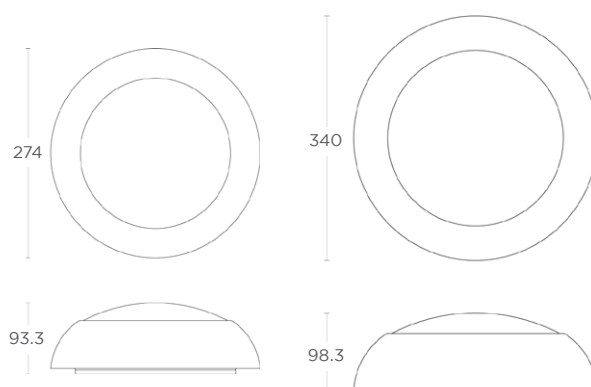

Residential Lighting Project?



Whatever the project, large or small, we make things easy. Our products are high in quality, performance and safety so you can 'fit and forget' – good for your client, good for your business!

Ask us about

- Expert advice on latest LED technology
- Smart Homes products and recommendations
- Control gear and spare parts for your light fittings
- Interior and exterior lighting including decorative and security

We can help whatever your residential sector

- Social Housing
- Housing Associations
- House builders
- University campus accommodation
- Private dwelling installs

Live in a better residential light

Find your local branch: [rexel.co.uk/store-finder](https://www.rexel.co.uk/store-finder)

View our Smart Homes catalogue and guide here:

[rexel.co.uk/interactive-catalogues](https://www.rexel.co.uk/interactive-catalogues)

REXEL

a world of energy

RadiaLED® Rapid Modular



Reviewing the channel and gaining valuable contractor feedback has become an essential requirement for JCC product development. RadiaLED® Rapid has been developed using feedback gathered from hundreds of electricians, providing strategic direction to create the most versatile and fastest to install product.



Material Construction

- Body: Polycarbonate
- Diffuser: Polycarbonate
- LED Tray: PA6 Nylon
- Rim: Polycarbonate



Designed with electricians, for electricians



Unique clip in tool-less LED gear tray design



Four side 20mm conduit entry points



Detachable loop-in/loop-out terminal block



	Wattage (W)	Lumens (lm)	Efficacy (Lm/W)	Colour Temperature (K)
8W VARIANTS	8	760	95	4000
12W VARIANTS	12	1260	104	4000
16W VARIANTS	16	1600	100	4000
24W VARIANTS	24	2160	90	4000

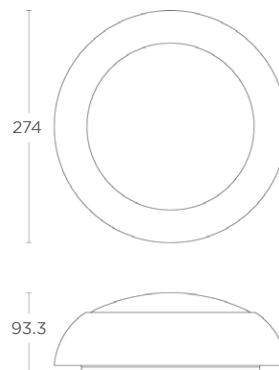

Product Builder...

- 1 Pick your body
- 2 Pick your wattage
- 3 Pick your variant
- 4 Pick your rim

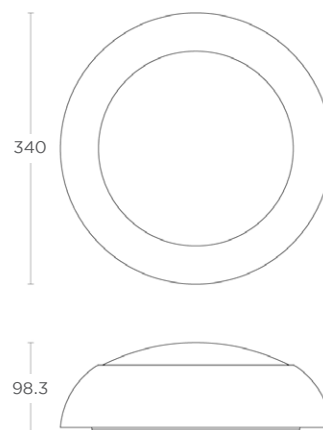

Small Body 274mm

Step 1	BODY	2501348320	RADIALED RAPID SMALL 8W IP65 BODY ONLY (W/O LED MODULE)				
Step 2	WATTAGE	8W	Emergency	Photocell	Microwave	Dimming	Dali/1-10V
Step 3	VARIANT	2501348266					
	VARIANT	2501348267	Y				
	VARIANT	2501348269		Y			
	VARIANT	2501348270	Y	Y			
	VARIANT	2501348271			Y		
	VARIANT	2501348272	Y		Y		
	VARIANT	2501348273				Y	
	VARIANT	2501348274	Y			Y	
	VARIANT	2501348275					Y
	VARIANT	2501348276	Y				Y
Step 4	RIM	2501348260	RADIALED RAPID 8W RIM WHITE				
	RIM	2501348261	RADIALED RAPID 8W RIM BLACK				
	RIM	2501348262	RADIALED RAPID 8W RIM CHROME				
	RIM	2501348263	RADIALED RAPID 8W RIM SATIN CHROME				
	RIM	2501348264	RADIALED RAPID 8W RIM SATIN SILVER				
	RIM	2501348265	RADIALED RAPID 8W RIM BLACK EYELID				

Large Body 340mm

Step 1	BODY	2501348321	RADIALED RAPID LARGE 12W/16W/20W IP65 BODY ONLY (W/O LED MODULE)							
Step 2	WATTAGE	12W	16W	24W	Standard Module	Emergency	Photocell	Microwave	Dimming	Dali/1-10V
Step 3	VARIANT	2501348277	2501348283	2501348288	Y					
	VARIANT	2501348294	2501348299	2501348305		Y				
	VARIANT	2501348278	2501348284	2501348289			Y			
	VARIANT	2501348295	2501348300	2501348306		Y	Y			
	VARIANT	2501348280	2501348285	2501348291				Y		
	VARIANT	2501348296	2501348302	2501348307		Y		Y		
	VARIANT	2501348281	2501348286	2501348292					Y	
	VARIANT	2501348297	2501348303	2501348308		Y			Y	
	VARIANT	2501348282	2501348287	2501348293						Y
	VARIANT	2501348298	2501348304	2501348309		Y				Y
Step 4	RIM	2501348253	RADIALED RAPID 12W/16W/24W RIM WHITE							
	RIM	2501348254	RADIALED RAPID 12W/16W/24W RIM BLACK							
	RIM	2501348255	RADIALED RAPID 12W/16W/24W RIM CHROME							
	RIM	2501348256	RADIALED RAPID 12W/16W/24W RIM SATIN CHROME							
	RIM	2501348258	RADIALED RAPID 12W/16W/24W RIM SATIN SILVER							
	RIM	2501348259	RADIALED RAPID 12W/16W/24W RIM BLACK EYELID							

Golf LED

ROBUS®

Utilising the latest Surface Mount Diode LED technology combined with high efficiency Pro-diffuser, the LED GOLF Family provides one of the most energy and maintenance savings solutions available. Versatility is enhanced with options of integral microwave sensor, emergency and emergency sensor versions.



Material Construction

- High impact polycarbonate construction (IK09 to EN62262)



Available as an integral sensor version with fully selectable parameters where external sensors may be difficult to install



New high efficiency pro-diffuse



Emergency, microwave sensor, and emergency sensor versions available



Order No.	Model No.	Description	Version	Wattage (W)	Lumens (lm)	Efficacy (Lm/W)	Colour Temperature (K)
2500802641	R075LED-01	GOLF 7.5W LED		7.5	640	91	4000
2500802642	R075LEDE-01	GOLF 7.5W LED	EMERGENCY	7.5	650	90	4000
2500821309	R075LEDS-01	GOLF 7.5W LED	SENSOR	7.5	640	91	4000
2500584189	R100LED-01	GOLF 10W LED		10	860	82	4000
2500584191	R100LEDE-01	GOLF 10W LED	EMERGENCY	10	860	67	4000
2500790561	R100LEDS-01	GOLF 10W LED	SENSOR	10	860	82	4000
2500790560	R100LEDES-01	GOLF 10W LED	SENSOR EMERGENCY	10	860	82	4000
2500802647	R150LED-01	GOLF 15W LED		15	1250	86	4000
2500802648	R150LEDE-01	GOLF 15W LED	EMERGENCY	15	1250	86	4000
2500821311	R150LEDS-01	GOLF 15W LED	SENSOR	15	1250	84	4000
2500822250	R150LEDES-01	GOLF 15W LED	SENSOR EMERGENCY	15	1250	86	4000

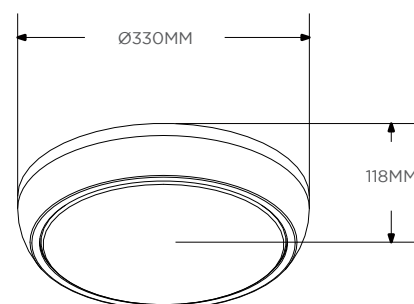

LED Slim Wallpack

A robust slim LED wallpack luminaires ideal for walkways, car parks, accent, building and perimeter lighting.



Material construction

- Polycarbonate body - Black
- Opal polycarbonate diffuser



Attractive slim design for more discreet installation requirements



Hinged and retained diffuser with stainless steel screws for easy maintenance



Photocell option available



Order No.	Model No.	Description	Wattage (W)	Lumens (lm)	Efficacy (Lm/W)	Colour Temperature (K)
2501182983	R1L-SL-30-4K	LED WALLPACK	30	3310	110	4000
2501182984	R1L-SL-30-PC-4K	LED WALLPACK & PHOTOCELL	30	3310	110	4000

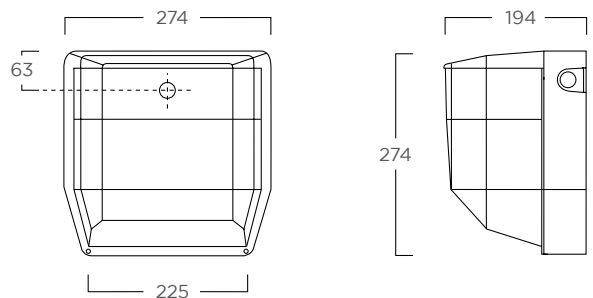

LED Bulkhead

An LED bulkhead that is suitable for use with conduit installations that can be surface mounted or direct entry through the side/top knockouts.



Material construction

- Polycarbonate body - grey/black
- Opal polycarbonate diffuser



Multiple side and rear conduit entries for flexible installation



Quick and easy speed fit terminals



Order No.	Model No.	Description	Wattage (W)	Lumens (lm)	Efficacy (Lm/W)	Colour Temperature (K)
2501120806	LBS1G4-01	LED BULKHEAD SQUARE GREY	4.5	400	89	4000
2501120807	LBS2G8-01	LED BULKHEAD RECTANGULAR GREY	7	750	107	4000
2501120808	LBS2G8MW-01	LED BULKHEAD RECTANGULAR MICROWAVE GREY	7.5	750	100	4000



Order No.	Model No.	Description	Wattage (W)	Lumens (lm)	Efficacy (Lm/W)	Colour Temperature (K)
2501022051	NLLRB14K	LED BULKHEAD BLACK	8	650	81	4000
2501022052	NLLRB1PIR4K	LED BULKHEAD PIR BLACK	8	650	81	4000

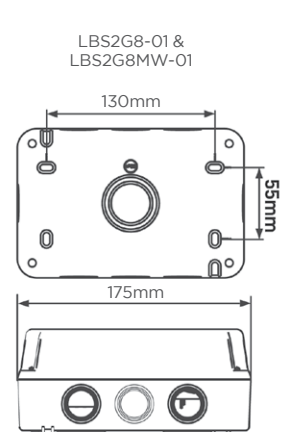
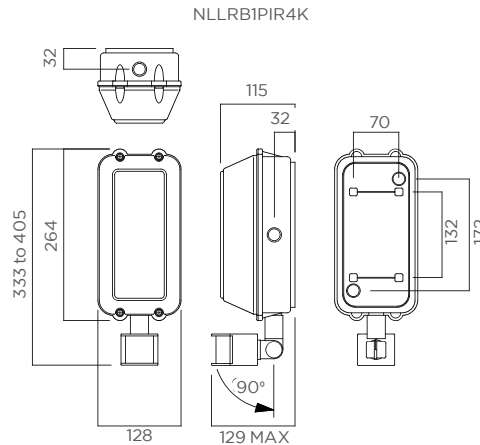
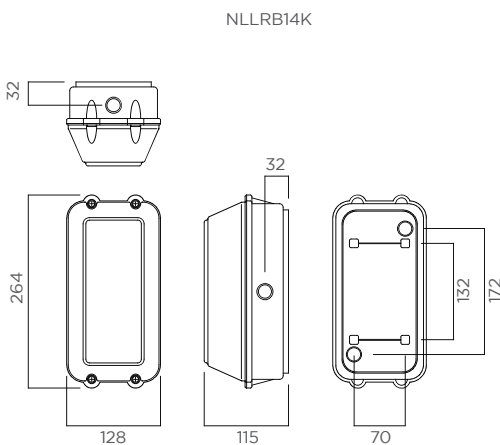
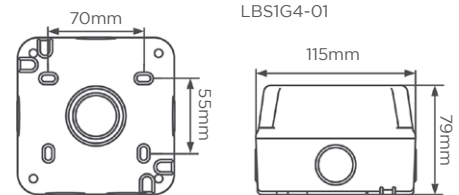

LED Wall & Coach Lanterns

A range of stylish lanterns available in the traditional 6 sided shape for retrofit or a 4 sided lantern for a more modern look. With the added flexibility of using LED lamps in different colours or upgrading to a smart lamp.



Material construction

- Polypropylene body
- Opal polycarbonate diffuser



Can be used either upward or downward (Non-PIR version)



PIR Option available for added energy saving



Lightweight product for easy install and maintenance



Lamps not included

Order No.	Model No.	Description	Sides
2501182920	KSR1510	OUTDOOR E27 LANTERN UP/DOWN	4
2501182921	KSR1511	OUTDOOR E27 LANTERN PIR	4
2501182922	KSR1514	OUTDOOR E27 LANTERN UP/DOWN	6
2501182923	KSR1515	OUTDOOR E27 LANTERN PIR	6
2501182924	KSR1158BLK	OUTDOOR E27 BLACK LANTERN	COACH
2501182925	KSR1159BLK	OUTDOOR E27 BLACK LANTERN PIR	COACH



KSR1159BLK

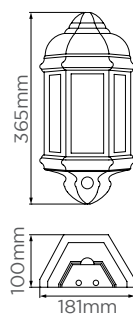

KSR1514

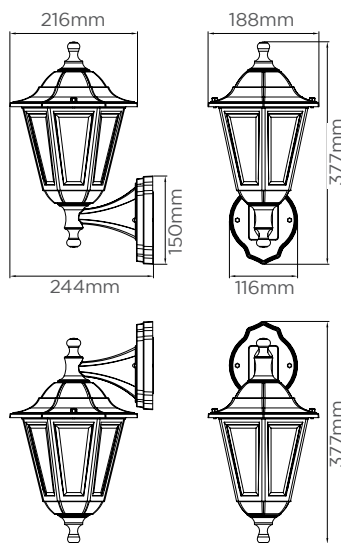

KSR1510

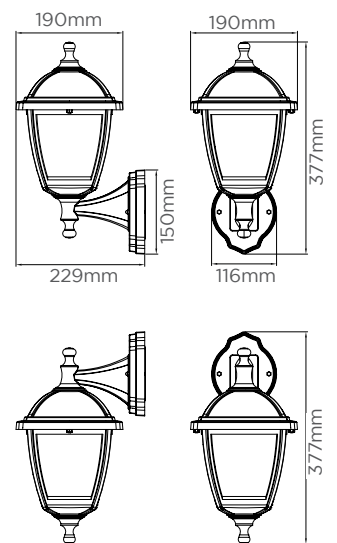

LED GU10 Wall and Ground Lights

An outdoor range of exterior spotlights that complement each other including a spike light, round up light and a round up/down light. Suitable for use in high saline coastal areas. With the added flexibility of using the LED GU10 in different colours or upgrading to a smart lamp.



Material construction

- Body - Polypropylene black
- Diffuser - Polycarbonate clear



Spike light supplied with 1M cable



Lamps not included

Order No.	Model No.	Description
2501182926	KSR1500	GU10 BLACK WALL LIGHT DOWN
2501182927	KSR1501	GU10 BLACK WALL LIGHT UP/DOWN
2501182928	KSR1504	GU10 BLACK SPIKE LIGHT

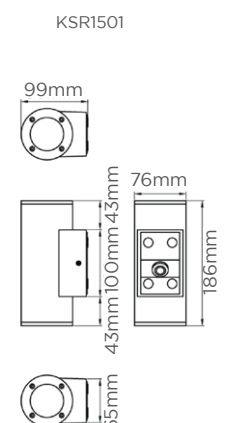
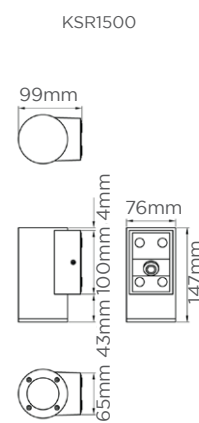
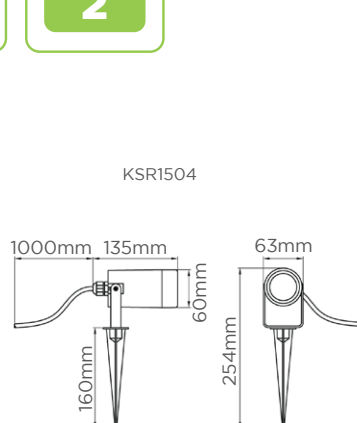

LED GU10 Wall and Ground Lights

An outdoor range of exterior spotlights that complement each other including a spike light, round up light and a round up/down light. Not suitable for use in high saline coastal areas. With the added flexibility of using the LED GU10 in different colours or upgrading to a smart lamp.



Material construction

- Body - Aluminium Black
- Lens - Glass



Spike light supplied with 2M of Pre-wired flex



Lamps not included

Order No.	Model No.	Description
2501182929	KSR1342	GU10 BLACK ALU WALL LIGHT DOWN
2501182930	KSR1343	GU10 BLACK ALU WALL LIGHT UP/DOWN
2501182931	KSR1344	GU10 BLACK ALU SPIKE LIGHT

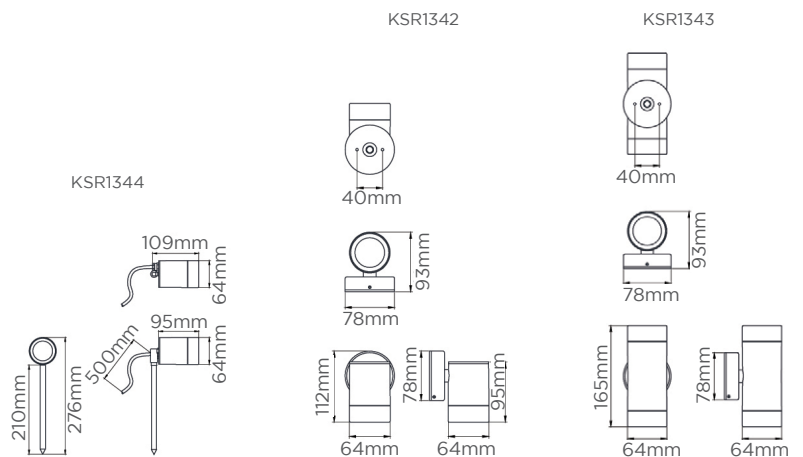

LED GU10 Wall and Ground Lights

An outdoor range of exterior spotlights that complement each other including a spike light, round up light and a round up/down light. Not suitable for use in high saline coastal areas. With the added flexibility of using the LED GU10 in different colours or upgrading to a smart lamp.



Material construction

- Body - Stainless Steel
- Lens - Glass



Spike light supplied with 400mm of Pre-wired flex



Lamps not included

Order No.	Model No.	Description
2501182932	KSR1315	GU10 S/STEEL WALL LIGHT DOWN
2501182933	KSR1316	GU10 S/STEEL WALL LIGHT UP/DOWN
2501182934	KSR1340	GU10 S/STEEL WALL LIGHT DOWN & PIR
2501182935	KSR1341	GU10 S/STEEL WALL LIGHT UP/DOWN & PIR
2501182936	KSR1319	GU10 S/STEEL SPIKE LIGHT



KSR1341

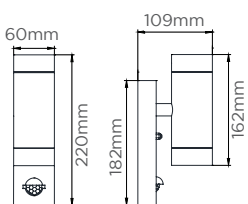

KSR1340

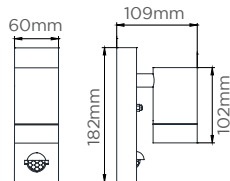

KSR1316

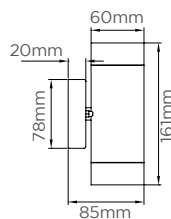

KSR1315

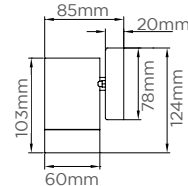

KSR1319

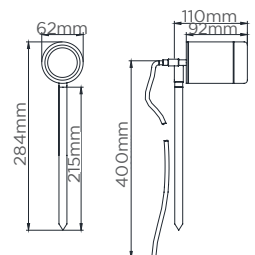



Holly Wall-Mounted LED Outdoor Luminaires

Pure and beautiful from within. Ideal for building facades and residential.



Material Construction

- Aluminium die-cast (RAL 9002)
- Front cover: clear glass



3 different designs (round, square, can)



Versions with up/downlight or only downlight to reduce light pollution



Special designed back plate provides more flexibility in mounting



ROUND



CAN



SQUARE

Order No.	Model No.	Description	Wattage (W)	Lumens (lm)	Efficacy (Lm/W)	Colour Temperature (K)
2501361224	96633683	HOLLY CONE ROUND DOWN IP65 300 830	5	301	60	3000K
2501361225	96633684	HOLLY CONE ROUND UP/DOWN IP65 500 830	8	500	63	3000K
2501361227	96633685	HOLLY CONE SQUARE DOWN IP65 300 830	5	301	60	3000K
2501361228	96633686	HOLLY CONE SQUARE UP/DOWN IP65 500 830	8	500	63	3000K
2501361229	96633687	HOLLY WALL CAN DOWN IP65 250 830	8	251	31	3000K

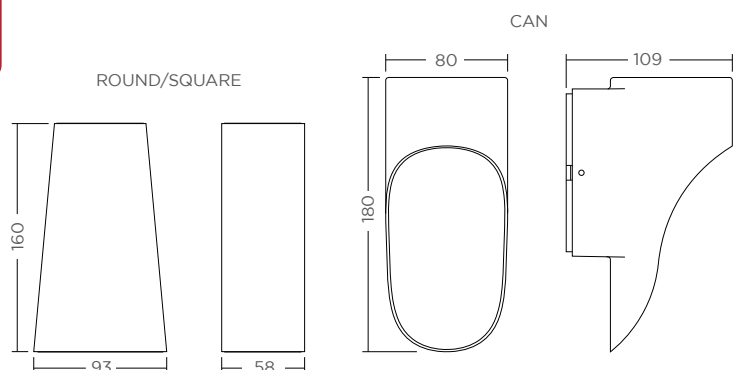



Rosy LED Walkover Inground Luminaire

Subtly stable Rosy illuminates your way, always in touch with others. Ideal for gardens, footpaths and residential.



Material Construction

- Body: stainless steel AISI 316, aluminium die-cast
- Screws: hex socket, stainless steel AISI 316 with GEOMET® 500 coating
- Front cover: tempered frosted glass
- Sleeve: PC



Compatible with THORNeco's Cable system - pages 74 & 75



Low overall height decreases required space and depth for installation



Suitable for installation in concrete/soil/wood



High corrosion resistance (C4)



Adaptor with open leads included



Order No.	Model No.	Description	Wattage (W)	Lumens (lm)	Efficacy (Lm/W)	Colour Temperature (K)
2501361209	96633582	ROSY INGROUND IP67 350 830	6	350	58	3000k

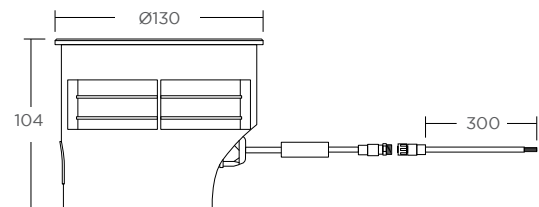



Mary LED Garden Floodlight With Earth Spike

Flexible and dynamic, Mary loves to communicate with others. Ideal for gardens and residential.



Material Construction

- Body: aluminium die-cast (RAL 9005)
- Screws: stainless steel AISI 316 with GEOMET® 500 coating
- Front cover: clear glass



Reflector for a sharp and defined light beam



Complete product with earth spike



Compatible with THORNeco's Cable system - pages 74 & 75



High corrosion resistance (C4)



Adaptor with open leads included



Order No.	Model No.	Description	Wattage (W)	Lumens (lm)	Efficacy (Lm/W)	Colour Temperature (K)
2501361210	96633583	MARY GARDEN SPOT IP66 500 830	8	500	62	3000K

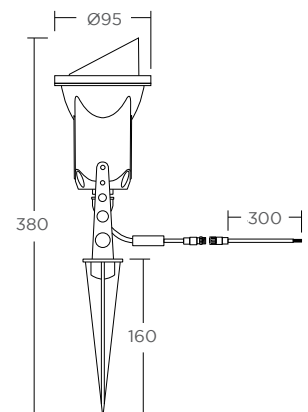

Around The House – Cable System

Plug&Play Cable system. Ideal for gardens. Discover THORNeco's easy PLUG&PLAY concept for gardens, pathways and building surrounds.

The THORNeco cables, connectors and sensors can be combined easily and are compatible with Mary (LED garden floodlight) and Rosy (LED Inground luminaire).

The THORNeco cable system allows quick and safe installation and provides maximum flexibility.

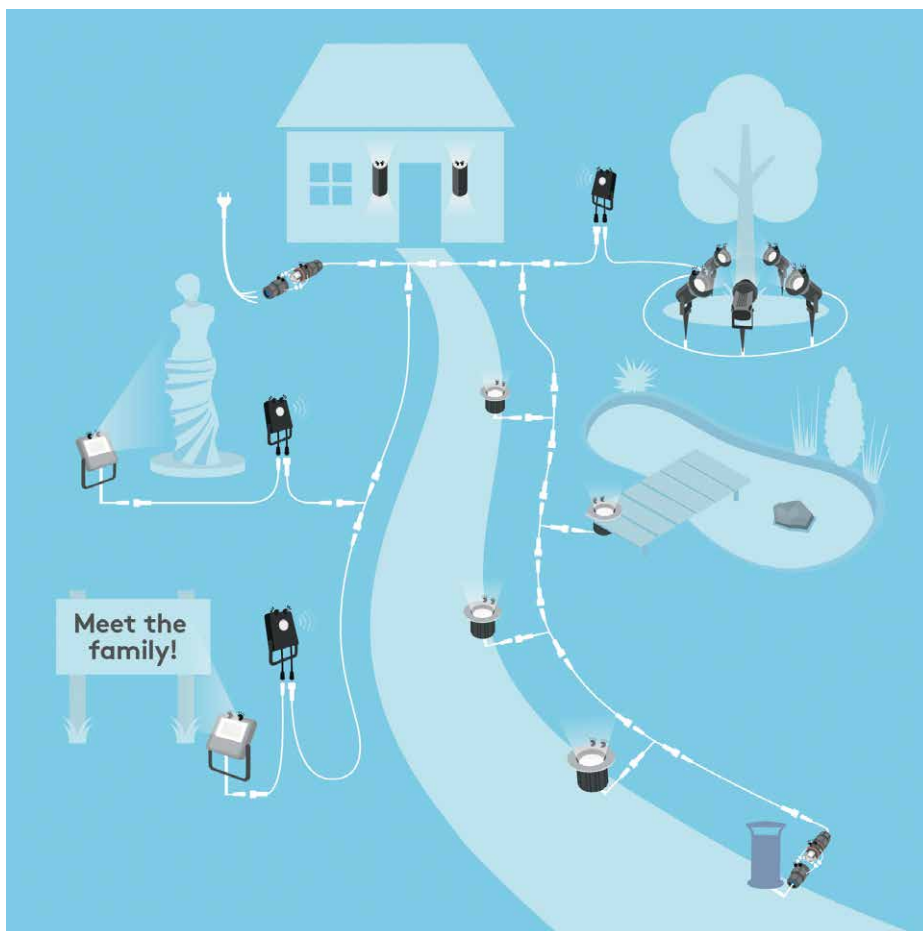

Material Cable System









Flexible cable H07RN-F 3 G 1.5 mm²



IP68

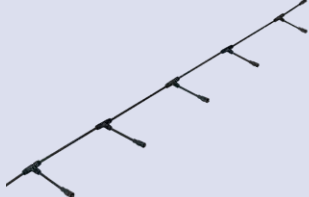

3 pole

Order No.	Model No.	Description	Image
2501361216	96633588	ECO MAINS ADAPTOR	
2501361217	96633589	ECO EXTERNAL PRODUCT INTEGRATOR - ALLOWS INTEGRATION OF NON THORN ECO PRODUCTS INTO SYSTEM	
2501361214	96633587	ECO EXTENSION CABLE 10M	
2501361211	96633584	ECO EXTENSION CABLE 1M	
2501361212	96633585	ECO EXTENSION CABLE 2M	
2501361213	96633586	ECO EXTENSION CABLE 5M	
2501361219	96633591	ECO MULTICONNECTOR	
2501361218	96633590	ECO T-CONNECTOR	
2501361221	96634061	ECO PHOTOCELL SENSOR	
2501361220	96633592	ECO PIR SENSOR WITH REMOTE	
2501361222	96634062	ECO SPARE REMOTE CONTROL	

LED Solar Lights

A range of residential solar lights perfect for outdoor areas with no mains power available. Front and rear facing LED light chips provide both functional, environmentally friendly and ambient illumination.



No wiring, easy & simple installation



Automatically turns on to standby glow mode when it gets dark (<30lux) and boosts to full power when occupancy detected



Available in a wall or floodlight fitting dependant on required light area



Lifetime hours are not applicable as the light output is based on the amount of sunlight received



RXL-LEXSL20B40-01



RXL-LEXSF11B40-01



RXL-LEXDSL1S40P-01



RXL-LEXS22B40-01

Order No.	Model No.	Description	Colour	Wattage (W)	Lumens (lm)	Efficacy (Lm/W)	IP Rating	Warranty
2501120817	LEXSL20B40-01	WALL LANTERN	BLACK	2	200	100	IP44	1
2501120818	LEXDSL1S40P-01	WALL LIGHT	S/STEEL	2	100	50	IP44	1
2501120819	LEXS22B40-01	WALL LIGHT	BLACK	1.5	220	147	IP65	1
2501120823	LEXSF11B40-01	FLOODLIGHT	BLACK	10	1080	108	IP65	2

CLASS 1

LEXSL20B40-01

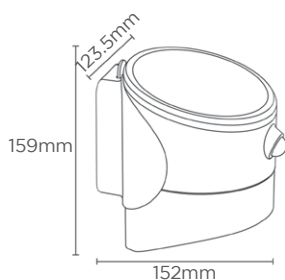

LEXDSL1S40P-01

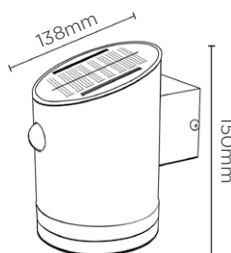

LEXS22B40-01

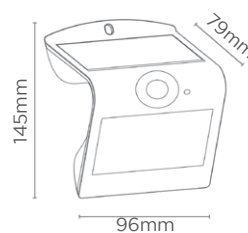

LEXSF11B40-01

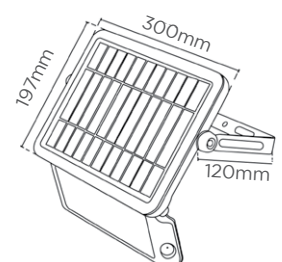

LED Decking Kit

A range of stylish decking kits to add a decorative touch to the garden while also increasing comfort lighting at night.



Materials construction

- Body - Plastic
- Rim - Stainless steel rim



Kit includes 10x heads and driver



RGB option available



Order No.	Model No.	Description	Wattage (W)	Colour Temperature (K)
2501182937	KSR1333W/W	DECKING KIT 3K	0.5	3000
2501182938	KSR1333C/W	DECKING KIT 6K	0.5	6000
2501182939	KSR1334RGB	DECKING KIT RGB	0.5	CCT

2501182937 / 2501182938

2501182939

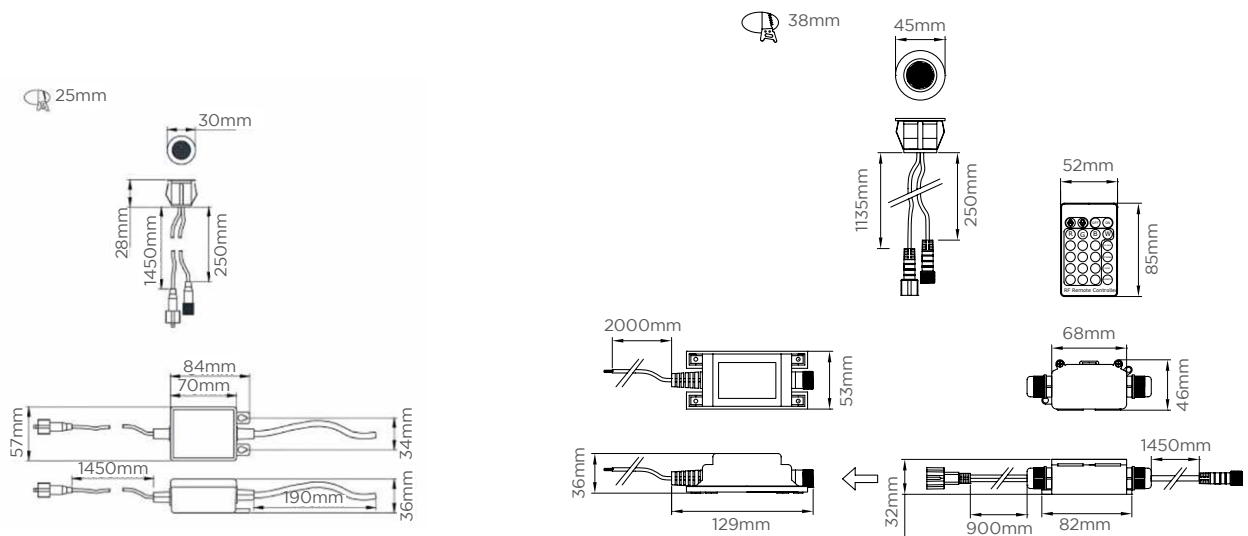

LED Outdoor Bulkhead

A range of round and oval bulkheads. Suitable for use in high saline coastal areas. With the added flexibility of using the LED lamp in different colours or upgrading to a smart lamp.



Material construction

- Polypropylene Body - Black
- Frosted Diffuser



Simple installation



Option upgrade from LED to Smart lamp



Lamps not included

Order No.	Model No.	Description
2501182940	KSR1505	ROUND WALL BULKHEAD E27
2501182941	KSR1506	OVAL WALL BULKHEAD E27



KSR1505

KSR1506

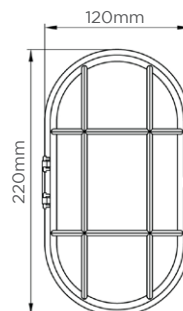
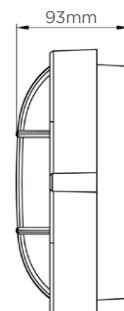
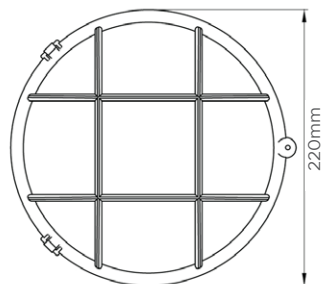
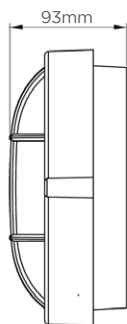

SMARTSTOCK



Rexel's intelligent stock and asset management system can save you time and costs and greater efficiencies in your business. Our flexible stock solutions for static stores, vans and vending on site can give you complete control, security, compliance and increased productivity - ask your local Rexel contact for more details or go to rexel.co.uk

CONTROL PRODUCTIVITY SECURITY SAVINGS

REXEL

a world of energy



REXEL.CO.UK

Street Lighting



LED Street Lights

A range of streetlights ideal for car parks, residential roads, parks and public amenity areas.



Material construction

- Housing - Aluminium Grey



Quick access for easy maintenance



Side entry 60mm diameter



Order No.	Model No.	Description	Lumens (lm)	Wattage (W)	Efficacy (Lm/W)	Diffuser Material	CRI	Colour Temperature (K)	Weight (kg)
2501182991	STL030V2	STREETLIGHT	3250	25	130	GLASS	70+	4000K	2.5
2501182992	STL031V2	STREETLIGHT	6500	50	130	GLASS	70+	4000K	2.6
2501182993	STL032V2	STREETLIGHT	9750	75	130	GLASS	70+	4000K	4.8
2501182994	STL033V2	STREETLIGHT	12350	95	130	GLASS	70+	4000K	4.9

Accessories

2501190229	ACS121	42-60MM SPIGOT ADAPTOR
2501190230	ACS122	34-60MM SPIGOT ADAPTOR



STL030V2 / STL031V2

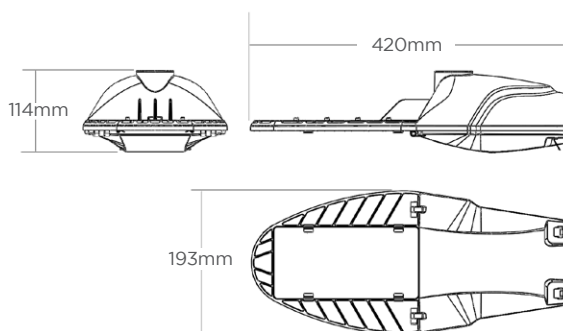

STL032V2 / STL033V2

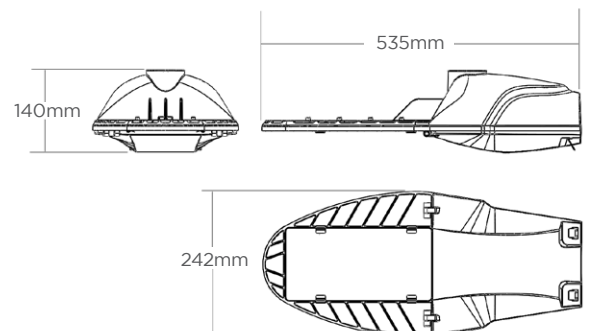

LED Street Lights

A range of streetlights ideal for car parks, residential roads, parks and public amenity areas.



Material construction

- Housing - Die aluminium powder coated grey
- Diffuser - PMMA



Tool free maintenance with clip in gear tray



60,000+ hours life L70



Post top entry 76mm diameter



Order No.	Model No.	Description	Lumens (lm)	Wattage (W)	Efficacy (Lm/W)	CRI	Colour Temperature (K)	Weight (kg)
2501182985	VI2S-28-1-4K-76	STREETLIGHT	3574	28	127	80+	4000k	6.5
2501182986	VI2S-56-2-4K-76	STREETLIGHT	7146	56	127	80+	4000k	6.5

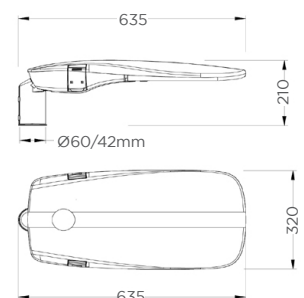
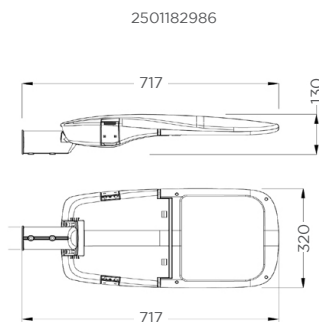
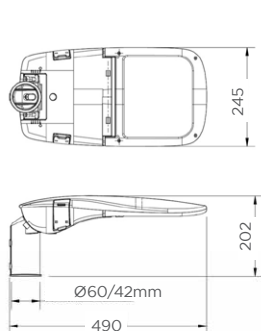
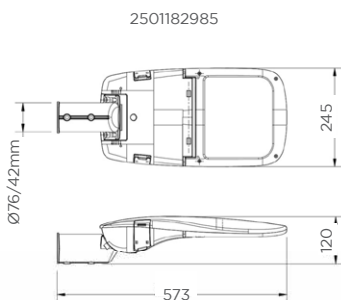

Plug IN

...to the EV opportunity

New EV charging catalogue and guide to growing your business with EV

ROLEC EV Charging wallbox   Schneider Electric  myenergi  GARO 



a world of energy



[REXEL.CO.UK](https://www.rexel.co.uk)

Site Lighting



LED Non Corrosive Work Light

An LED non corrosive work light range with a operating temperature of 0°C to +50°C, ideal for use in any indoor/outdoor commercial or industrial construction sites.



Material construction

- Polycarbonate - Yellow base
- Polycarbonate - Opal diffuser



120° Beam angle



Dual brackets included for suspension and wall mounting



3 hour emergency duration option available



Order No.	Model No.	Colour	Emergency	Wattage (W)	Lumens (lm)	Efficacy (Lm/W)	Colour Temperature (K)
2501310722	BI4112	2FT NON CORROSIVE 110V YELLOW BODY		27	3420	127	5000K
2501310723	BI4112E	2FT NON CORROSIVE 110V YELLOW BODY E3	Y	29	3420	118	5000K
2501310724	BI4115	5FT NON CORROSIVE 110V YELLOW BODY		40	4800	120	5000K
2501310725	BI4115E	5FT NON CORROSIVE 110V YELLOW BODY E3	Y	42	4800	114	5000K

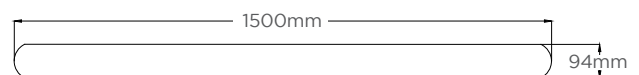
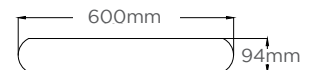
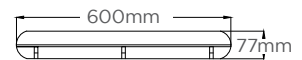

LED Non Corrosive Work Light

An LED Plasterers light perfect for working in both indoor and outdoor confined spaces, with operating temperatures of 0°C to +40°C.



Material construction

- Polycarbonate - Yellow base
- Polycarbonate - Opal diffuser



120° Beam angle



Supplied with foldaway stand for ease of storage and transportation



Supplied with two 16A outlet connections for linkable applications



5m lead and 16A 110V yellow plug



Order No.	Model No.	Colour	Wattage (W)	Lumens (lm)	Efficacy (Lm/W)	Colour Temperature (K)
2501182999	P1000	2FT NON CORROSIVE WORKLIGHT A-FRAME 110V	20	2200	110	6500
2501183000	P1010	2FT NON CORROSIVE WORKLIGHT TRIPOD 110V	20	2200	110	6500
2501183001	P1020	5FT NON CORROSIVE WORKLIGHT TRIPOD 110V	30	3300	110	6500

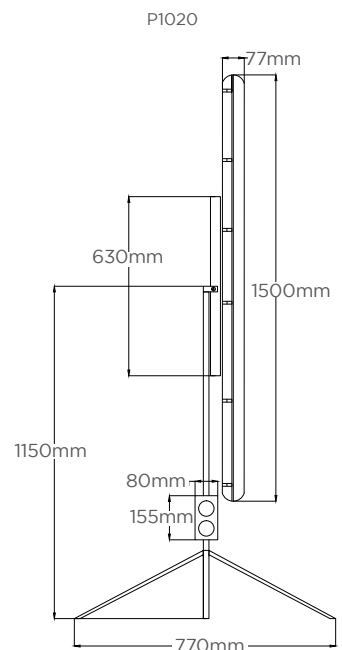
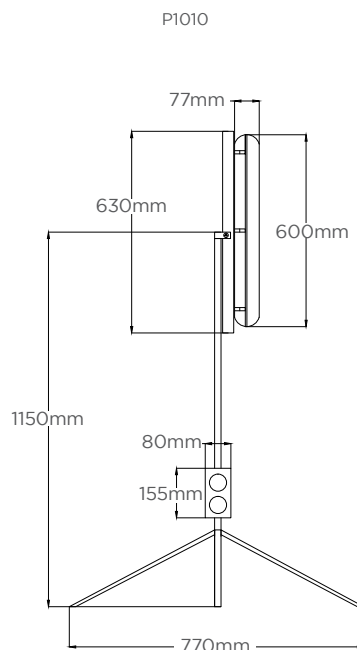
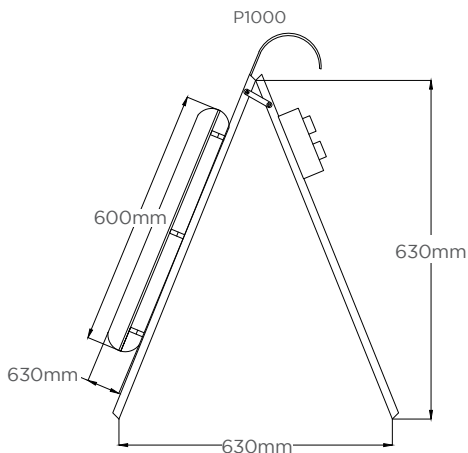

LED Portable Task Light

A range of task and tripod worklights perfect for indoor and outdoor illumination.



Material construction

- Aluminium body – Yellow
- Tempered glass cover



Complete with 1.5m lead and 16A plug



Order No.	Model No.	Colour	Wattage (W)	Lumens (lm)	Efficacy (Lm/W)	Colour Temperature (K)
2501183006	S4010	110v PORTABLE TASK LIGHT	10	900	90	4000K

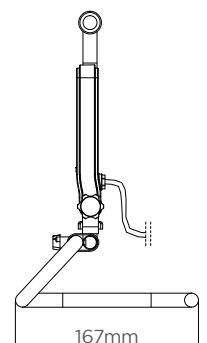
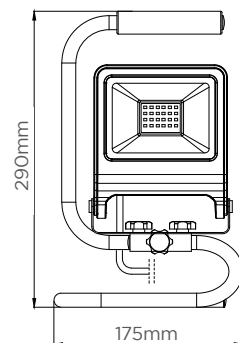

LED Tripod Worklight

A range of task and tripod worklights perfect for indoor and outdoor illumination.



Material construction

- Light fitting - Aluminium body - Yellow
- Tempered glass cover
- Tripod - Die cast Aluminium - Yellow



Comes with a telescopic tripod for easy storage and transportation



Complete with 3m lead and 16A plug



Order No.	Model No.	Colour	Wattage (W)	Lumens (lm)	Efficacy (Lm/W)	Colour Temperature (K)
2501183007	S4110	110V TRIPOD TASK LIGHT	10	900	90	4000K
2501183008	S4120	110V TWIN TRIPOD TASK LIGHT	10	900	90	4000K



S4110

S4120

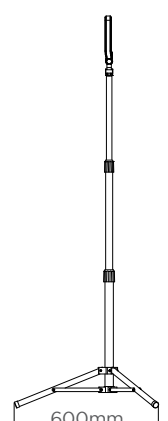
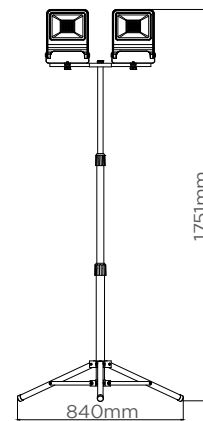
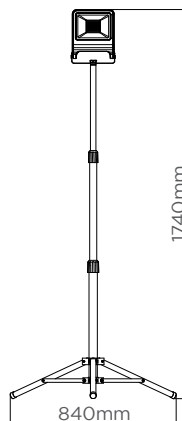

Site Floodlight

A range of floodlights suitable for use in industrial and commercial applications such as construction sites.



Material construction

- Aluminium body - Yellow
- Toughened glass cover



500mm lead



Order No.	Model No.	Colour	Wattage (W)	Lumens (lm)	Efficacy (Lm/W)	Colour Temperature (K)
2501183002	N6279	110V SITE FLOODLIGHT	50	4500	90	4000K
2501183003	N6280	110V SITE FLOODLIGHT	70	6300	90	4000K
2501183004	N6281	110V SITE FLOODLIGHT	100	9000	90	4000K
2501183005	N6282	110V SITE FLOODLIGHT	150	13500	90	4000K



N6279 / N6280 / N6281

N6282

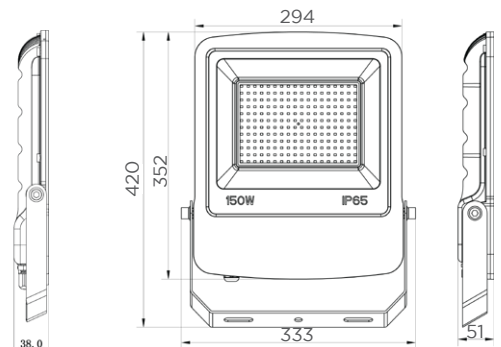
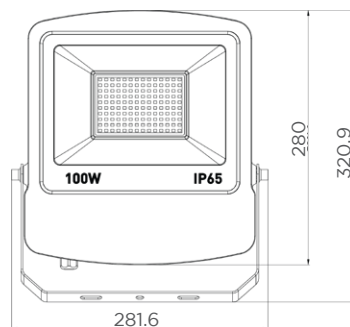

LED Festoon Kits

A range of festoon lighting kits that are an ideal temporary lighting solution for construction sites due to their light weight and flexibility.

- ✓ 22M Length with 2M Spacings
- 👍 Option to have festoon only or lamp included kit comes with 10 LED lamps
- ✓ 22m total festoon length with lampholder's every 2m, 10 in total
- ✓ Festoon kits are available with and without lamps



Order No.	Model No.	Description
2501183009	SEFLEDES	110V 22M KIT INC ES LAMPS
2501183010	SEFLEDBC	110V 22M KIT INC BC LAMPS
2501183011	SEFLKITES	110V 22M KIT EXCLUDING ES LAMPS
2501183012	SEFLKITBC	110V 22M KIT EXCLUDING BC LAMPS



Site Accessories

Extension Lead

- 🔌 Made with highly durable arctic grade cable
- 👍 Fitted with 16A 110v plug and coupler
- ✓ Must be used uncoiled





Order No.	Model No.	Description	Length (Metres)	Max Load Unwound	Max Load Wound	H Frame
2501183020	RXL-SE3010	YELLOW 1.5MM 16A EXT LEAD	14	1760	770	
2501183021	RXL-SE3030	YELLOW 2.5MM 16A EXT LEAD	14	1760	770	
2501183022	RXL-SE3050	YELLOW 1.5MM 16A EXT LEAD	25	1760	770	Y
2501183023	RXL-SE3070	YELLOW 2.5MM 16A EXT LEAD	25	1760	770	Y



Site Accessories

A range of site accessories ideal for domestic, commercial and industrial applications.

110V Transformers

-  Robust GRP case with carry handle
-  Resettable thermal cut out
-  Supplied with 2M cable and 13A plug





Order No.	Model No.	Colour	Intermittent Rating	Continuous Rating	Weight
2501183013	1000/2/B	1000VA SITE TRANSFORMER	1.0KVA	0.6KVA	12.5
2501183014	1500/2/B	1500VA SITE TRANSFORMER	1.5KVA	0.9.KVA	13
2501183015	3300/2/B	3300VA SITE TRANSFORMER	3.3KVA	2.2KVA	18
2501183016	5000/3/B	5000VA SITE TRANSFORMER	5KVA	2.8KVA	29

1
YEAR
WARRANTY

IP44

Power Splitter

-  Power splitter with four 16A 110V outlets
-  Heavy duty yellow steel case with carry handle
-  Complete with lead and 16A 110V plug



Order No.	Model No.	Colour	Lead Length	Sockets
2501183017	RXL-PS45	POWER SPLITTER WITH CABLE	2.5M	4

1
YEAR
WARRANTY

IP44

Hazardous Area



LED Zone 1 Area Light

A range of high quality corrosion resistant Zone 1 Floodlights specifically designed for hazardous areas such as chemical sites, pharmaceutical, paint spray shops, refineries, off shore and any other area which requires high performance, and high reliability. Can be used in ambient temperature rating -40° to +55°C.



Material construction

- Aluminium body - turquoise
- Tempered glass lens



High quality corrosion resistant aluminium alloy body



Steel swivel mounting bracket



Order No.	Model No.	Description	Wattage (W)	Lumens (lm)	Efficacy (Lm/W)
2501310713	ALED4/G/Z1/156	ZONE 1 LED AREA LIGHT	86	10000	116
2501310714	ALED3/G/Z1/086	ZONE 1 LED AREA LIGHT	156	19000	122

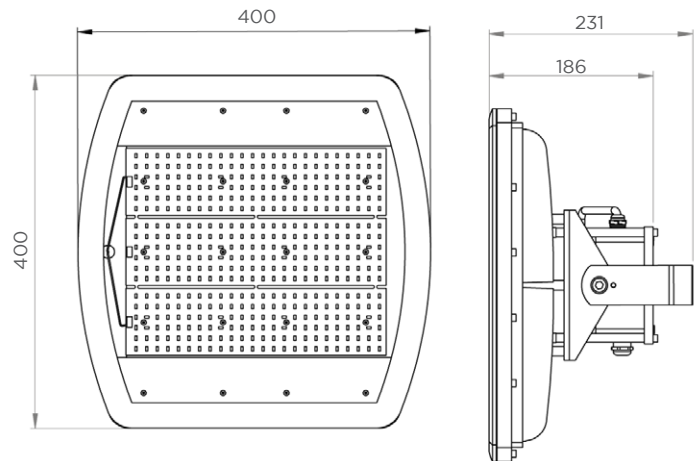

Zone 1 Linear

A range of zone 1 linear luminaire available in 2ft & 4ft. Ideal for use in chemical sites, pharmaceutical, paint spray shops, refineries and any other hazardous atmospheres where (gas and combustible dust) are potentially present. Can be used in ambient temperature rating -20° to +55°C.



Material construction

- Body - Anodised corrosion resistant aluminium - Turquoise & Grey
- Polycarbonate diffuser and end caps



Access to LED gear tray via single point locking mechanism



Mounting is enabled using “quick fit” T bolts in a channel for flexibility



Can be used in internal and external applications



LED Linear

Order No.	Model No.	Description	Emergency	Wattage (W)	Lumens (lm)	Efficacy (Lm/W)	Size A (mm)
2501310718	9LED2700	2FT LED ZONE 2 NON CORROSIVE		30	2100	70	760
2501310719	9LED2700/EM	4FT LED ZONE 2 NON CORROSIVE	Y	30	2100	70	760
2501310720	9LED4700	4FT LED ZONE 2 NON CORROSIVE		60	4200	70	1365
2501310721	9LED4700/EM	4FT LED ZONE 2 NON CORROSIVE	Y	60	4200	70	1365

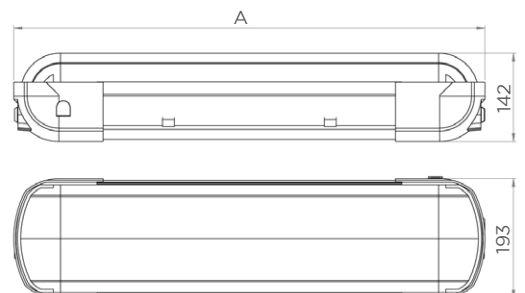

Zone 2 Non Corrosive

A range of Zone 2 weatherproof luminaire available in 2ft & 4ft. Ideal for use in chemical sites, pharmaceutical, paint spray shops, refineries and any other hazardous atmospheres where (gas and combustible dust) are potentially present. Can be used in ambient temperature rating -20° to +51°C.



Material construction

- Body - GRP Moulded body - Grey
- Polycarbonate diffuser
- Corrosion resistant gear tray & diffuser



Unrestricted breathing protection means no annual inspection costs



Stainless steel clips for reduced corrosion



Push fit gear tray for simple, fast installation



Emergency options available

LED Non Corrosive

Order No.	Model No.	Description	Emergency	Wattage (W)	Lumens (lm)	Efficacy (Lm/W)	Size (A)
2501310715	XNLED127	2FT LED ZONE 2 NON CORROSIVE		30	2650	88	702
2501310716	XNLED147	4FT LED ZONE 2 NON CORROSIVE		60	5300	88	1312
2501310717	XNLED147/EM	4FT LED ZONE 2 NON CORROSIVE	Y	60	5300	88	1312

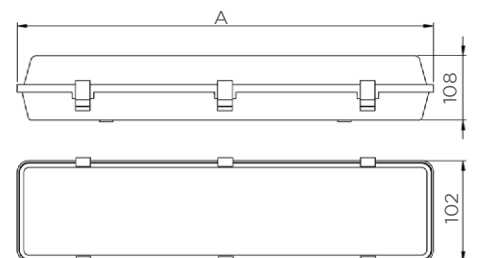

Display Lighting



LED 240V GU10 Downlights

Our range of GU10 downlights offers a fully flexible solution for residential, retail or hospitality application. The bezels are quick and easy to install with a twist and lock mechanism allowing them to be removed as required for first fix or remedial works.

FIT + FORGET Tool free push fit connector loop in/out for quick and easy connection

 Spring clips - to minimise ceiling damage if removal required

 72mm cut out



How to order

Step 1

Order the recessed frame and lamp holder

Step 2

Order the required accessory

Order No.	Model No.	Description
2501182942	KSRDL400	FIXED RECESSED FRAME
2501182943	KSRDL402	FIXED LAMPHOLDER

Accessories

2501182944	KSRDL420	WHITE RIM PIN WALL WASH
2501182945	KSRDL425	WHITE RIM WHITE BAFFLE TRIM
2501182946	KSRDL426	WHITE RIM BLACK BAFFLE TRIM
2501182947	KSRDL427	WHITE RIM CHROME BAFFLE TRIM
2501182948	KSRDL428	WHITE RIM MATT GOLD BAFFLE TRIM
2501182949	KSRDL429	WHITE RIM ROSE GOLD BAFFLE TRIM
2501097862	NLFRDWHI20	TRIM WHITE IP20
2501097863	NLFRDCHR20	TRIM CHROME IP20
2501097864	NLFRDS/CHR20	TRIM SATIN CHROME IP20
2501097865	NLFRDWHI65	TRIM WHITE IP65
2501097866	NLFRDCHR65	TRIM CHROME IP65
2501097867	NLFRDS/CHR65	TRIM SATIN CHROME IP65

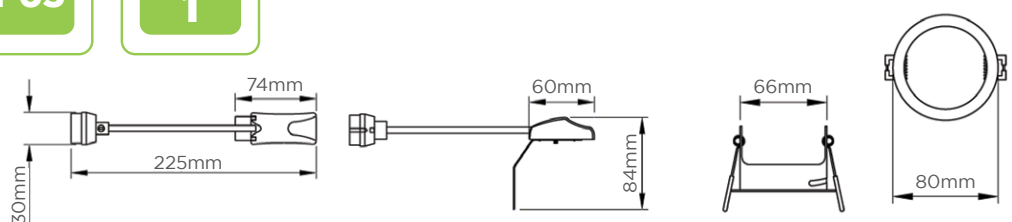

LED Fire Rated GU10 Downlights

Our range of fire rated downlights offers a fully flexible solution for residential, retail or hospitality application. The bezels are quick and easy to install with a twist and lock mechanism allowing them to be removed as required for first fix or remedial works. The fire rated downlights are UK Building Regulations compliant to part B, C, E and L (depending on the lamp used).



Fully fire rated 30, 60, 90 mins - Building Regulations Part B Compliant - Tested For Use in Solid, I-Joist and Steel Open Web Joist ceilings



Tool free push fit connector loop in/out for quick and easy connection



Insulation coverable - fit and forget



Spring clips - to minimise ceiling damage if removal required



Order No.	Model No.	Description
2501097861	NLFRDGUI0	FIRE RATED CAN GU10

Accessories

2501097862	NLFRDWHI20	TRIM WHITE IP20
2501097863	NLFRDCHR20	TRIM CHROME IP20
2501097864	NLFRDS/CHR20	TRIM SATIN CHROME IP20
2501097865	NLFRDWHI65	TRIM WHITE IP65
2501097866	NLFRDCHR65	TRIM CHROME IP65
2501097867	NLFRDS/CHR65	TRIM SATIN CHROME IP65

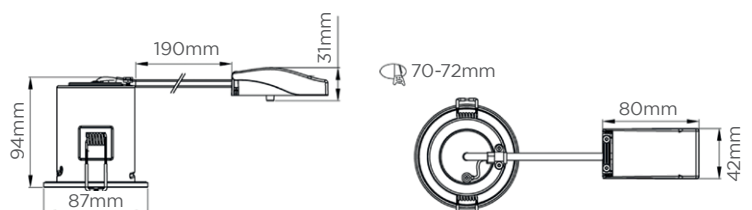

LED Integrated Downlights

A range of residential LED downlights with twist and lock bezels which allow quick and easy first fix or the ability to change the bezel finish without removing the luminaire.

- ✓ Tool free loop in/loop out wiring
- 👍 Insulation coverable
- 🔥 30, 60 & 90 minute fire rated – Building Regulations Part B compliant
- 🌊 Condensation/air leakage tested – Building Regulations Part C compliant
- 🔊 Acoustically rated – Building Regulations Part E compliant
- ☀️ Efficiency of over 82 lm/W – Building Regulations Part L compliant
- 📐 55° beam angle for increased light output
- ✓ Suitable for James Jones or Staircraft 220mm + deep I-Joists



Order No.	Model No.	Description	Wattage (W)	Lumens (lm)	Efficacy (Lm/W)	Colour Temperature (K)
2500987650	NLFRDL1	LED FIRE RATED DOWNLIGHT	4.8	400	83	3000
2500987651	NLFRDL2	LED FIRE RATED DOWNLIGHT	4.8	400	83	4000
2500987652	NLFRDL3	LED FIRE RATED DOWNLIGHT PLUS	6.7	550	82	3000
2500987653	NLFRDL4	LED FIRE RATED DOWNLIGHT PLUS	6.7	550	82	4000

Accessories

2500987656	NLFRDLTW	WHITE TRIM
2500987657	NLFRDLTC	CHROME TRIM
2500987658	NLFRDLTSC	SATIN CHROME TRIM

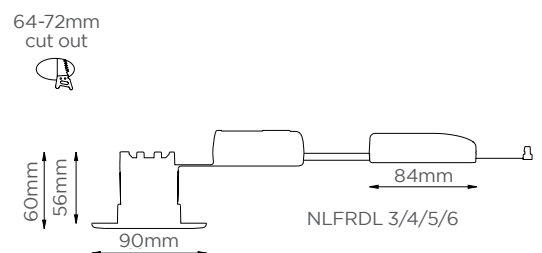
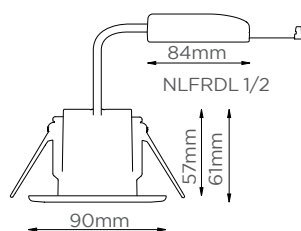

LED Fire Rated Downlights Colour Switchable

This versatile fire rated downlight can be switched to either 3000K, 4000K or 6500K after installation. With a range of detachable bezels this is a fitting suitable for any application, both residential and commercial.



Material construction

- Steel body
- Aluminium bezel
- Polycarbonate lens



Tool free loop in/loop out wiring



30/60/90 minute fire rating and fully compliant with parts B, C, E & L of the building regulations



How does it work? Under the bezel a switch allows for colour changing between 3000K, 4000K & 6500K during or after install



Mains dimmable as standard



Insulation coverable



Suitable for James Jones or Staircraft



Order No.	Model No.	Description	Wattage (W)	Lumens (lm)	Efficacy (Lm/W)	Colour Temperature (K)
2501182899	DLT4564000	COLOUR SWITCHABLE FIRE RATED DL	4.5	400	89	3000, 4000, 6500
2501120794	DLT4566000	COLOUR SWITCHABLE FIRE RATED DL	6	550	92	3000, 4000, 6500

Accessories

2500987656	NLFRDLTW	WHITE TRIM
2500987657	NLFRDLTC	CHROME TRIM
2500987658	NLFRDLTSC	SATIN CHROME TRIM

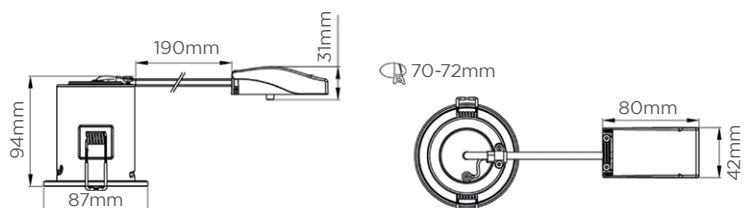



THE WAY
FORWARD IS
SMART
HOME

Smart home technology is increasing in popularity. Get clued up and kitted out with all the biggest brands at Rexel.

Go to [rexel.co.uk](https://www.rexel.co.uk) for more information.

REXEL

a world of energy

V50™ - Fire Rated LED Downlight - Colour Switchable

V50's low profile design enables the fitting to be installed in applications that have a shallow 50mm ceiling void, as well as featuring a simple 2-way switch that allows users to choose between either 3000k or 4000k colour temperature.



Material Construction

- Body: Steel
- Lens: Polycarbonate
- Bezel: Aluminium



Selectable colour temperature from beneath the ceiling



Ultra-low profile design suitable for shallow ceiling voids



70MM Cut out as standard. Use Converter plates for 80-120mm cut outs.



Tested for use in solid, I-Joist and steel open web joist ceilings*



Available as a complete fixture or without bezel (JC1001/NB)



Order No.	Model No.	Description	Wattage (W)	Lumens (lm)	Efficacy (Lm/W)	Colour Temperature (K)
2501091832	JC1001/NB	V50 WITHOUT BEZEL	7.5	600/650	80/87	3000K/4000K

Accessories

2501091758	JC1006/WH	WHITE BEZEL FOR V50
2501091747	JC1006/CH	CHROME BEZEL FOR V50
2501091724	JC1006/BN	BRUSHED NICKEL BEZEL FOR V50
2501091736	JC1006/BR	BRUSHED BRASS BEZEL FOR V50
2501091713	JC1006/BLK	BLACK BEZEL FOR V50
2501091636	JC1003/BN	V50 STANDARD PRODUCT CONVERTER PLATE IN BRUSHED NICKEL
2501091647	JC1003/CH	V50 STANDARD PRODUCT CONVERTER PLATE IN CHROME
2501091658	JC1003/WH	V50 STANDARD PRODUCT CONVERTER PLATE IN WHITE
2501091702	JC1005	V50 STANDARD PRODUCT CONCEALER RING (5 IN PACK)

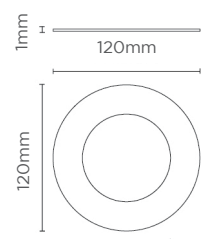
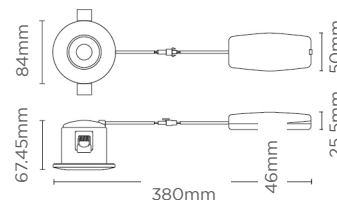
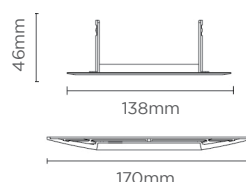

V50™ Tilt - Fire Rated LED Downlight - Colour Switchable



V50 Tilt is 350° rotatable and 20° tiltable allowing for installation in vaulted ceilings or for wall washing, whilst featuring a simple 2-way switch that allows users to choose between either 3000k or 4000k colour temperature.



Material Construction

- Body: Steel
- Lens: Polycarbonate
- Bezel: Aluminium



Selectable colour temperature switch located on driver



350° rotatable and 20° tiltable



Available in white, chrome and brushed nickel



85MM Cut out as standard. Use Converter plates for up to 120MM cut outs.



Tested for use in solid, I-Joist and steel open web joist ceilings*



Order No.	Model No.	Description	Wattage (W)	Lumens (lm)	Efficacy (Lm/W)	Colour Temperature (K)
2501091625	JC1002/WH	V50 TILT IN WHITE	7.5	600/650	80/87	3000K/4000K
2501091865	JC1002/CH	V50 TILT IN CHROME	7.5	600/650	80/87	3000K/4000K
2501091854	JC1002/BN	V50 TILT IN BRUSHED NICKEL	7.5	600/650	80/87	3000K/4000K

Accessories

2501091691	JC1004/WH	V50 TILT CONVERTER PLATE IN WHITE
2501091669	JC1004/BN	V50 TILT CONVERTER PLATE IN BRUSHED NICKEL
2501091680	JC1004/CH	V50 TILT CONVERTER PLATE IN CHROME

5
YEAR
WARRANTY
50,000 HOURS

TRIAC
DIMMABLE

CLASS
2

60°
BEAM

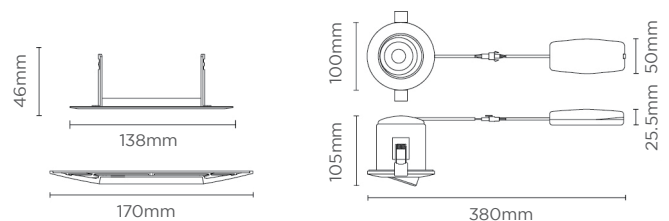

Need it tomorrow morning? Order by 5pm

LED Track Lights

A range of LED track heads and components that allow for installation combinations in domestic, commercial and retail applications.



Material construction

- Body - White RAL 9003
- Diffuser - Polycarbonate



Components in listing are all interchangeable and can be used in a range of installation combinations



Track heads allow for rotation of 350° and minimum tilt 180°



Dimmable option available



Order No.	Model No.	Description	Wattage (W)	Lumens (lm)	Efficacy (Lm/W)	Colour Temperature (K)
2501182956	RTY1040-01	WHITE LED TRACK HEAD	9.4	930	98	4000k
2501182957	RTK1240-01	WHITE LED TRACK HEAD	10.9	1150	106	4000k
2501182958	RTM2540-01	LED WHITE TRACK HEAD DIM	25	2240	89	4000k

Accessories

2501182959	R1T-01	LED 1M TRACK LENGTH
2501182960	R2T-01	LED 2M TRACK LENGTH
2501182961	RLE-01	TRACK LIVE/DEAD ENDS
2501182962	RL-01	TRACK L JOINER
2501182963	RC-01	TRACK COUPLER

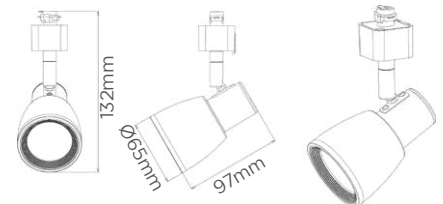
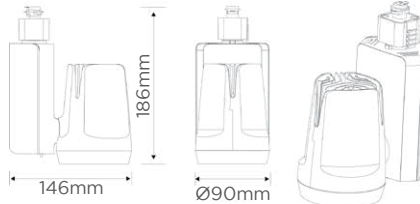
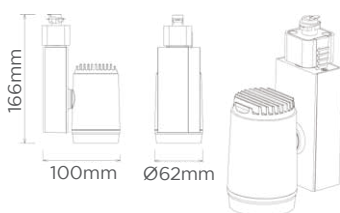

LED Spotlights

A complete range of decorative spotlights which offers style to any residential property perfect for lounge, kitchen or hallway. With the added flexibility of using the LED GU10 lamp in different colours or upgrading to smart lamps.



Material construction

- Steel - matt white



Dimmable dependent on type of lamp



360° rotation and 180° tilt perfect for directional lighting



Lamps not included

Order No.	Model No.	Description
2501182950	KSR6260WH	GU10 SINGLE SPOTLIGHT
2501182951	KSR6261WH	GU10 TWO BAR SPOTLIGHT
2501182952	KSR6262WH	GU10 THREE BAR SPOTLIGHT
2501182953	KSR6263WH	GU10 THREE PLATE SPOTLIGHT



KSR6261WH

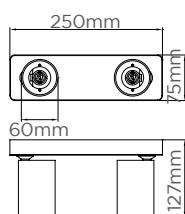

KSR6262WH

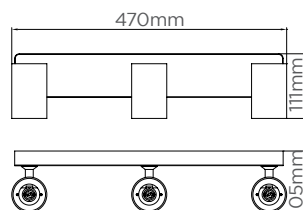

KSR6263WH

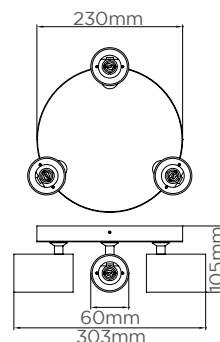

KSR6260WH

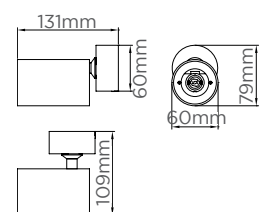

LED Flexi-Strip

This range of LED flexi-strip consists of single colour warm or neutral white strip which can be ordered by the metre. Provides a superb lighting effect for domestic, retail, commercial or entertainment venues.

 Cut to length

 Flexible

 Low profile

 Wi-Fi version available

 Added Protection

 3M tape/peel & stick

Cloud Connection



Alexa & Google Home Robus Connect is compatible with Amazon Alexa and Google Assistant. Just search for Smart Life in your Alexa or Google Home companion App.

This allows you to:

- Group other cloud-based devices
- Voice control

How to order?

- **Which LED Flexi-strip do you need?**
Waterproof (IP 67) or Non Waterproof (IP20)
12V Warm white or neutral white
- **How long do you need the LED Flexi strip and how many cuts?**
- **How do you want to control the LED Flexi-strip?**
Standard installation / Smart WIFI App
- **Which LED Driver?**
12V / 15W / 30W / 60 / 100W
- **Do you need connectors?**



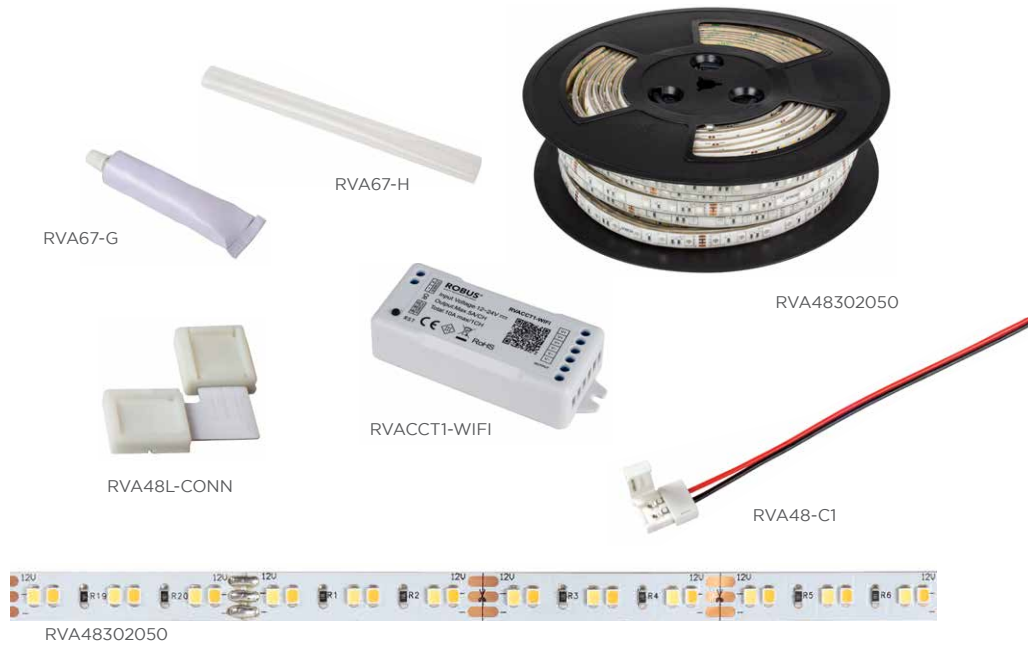

IP20

Steps	Order No.	Model No.	Description
Step 1 - Strips	2501310729	RVA48302050	LED STRIP 12V 4.8W/M 60LED/M IP20 3000K 1M LENGTH
	2501310731	RVA48402050	LED STRIP 12V 4.8W/M 60LED/M IP20 4000K 1M LENGTH
Step 2 - Drivers	2501310733	RVA1512-PSU	LED STRIP DRIVER 12V 15W IP20 CONSTANT VOLTAGE
	2501310734	RVA3012-PSU	LED STRIP DRIVER 12V 30W IP20 CONSTANT VOLTAGE
	2501310735	RVA6012-PSU	LED STRIP DRIVER 12V 60W IP20 CONSTANT VOLTAGE
	2501310736	RVA10012-PSU	LED STRIP DRIVER 12V 100W IP20 CONSTANT VOLTAGE
Step 3 - Connectors	2501310737	RVA48-C	LED STRIP CLIP CONNECTOR STRIP-STRIP NO LEAD
	2501310738	RVA48-C1	LED STRIP CLIP CONNECTOR STRIP-DRIVER 150MM LEAD
	2501310739	RVA48-C2	LED STRIP CLIP CONNECTOR STRIP-STRIP 150MM LEAD
	2501310740	RVA48L-CONN	LED STRIP CLIP L CONNECTOR IP20
Step 4 - WiFi controller	2501310747	RVACCT1-WIFI	LED STRIP WIFI CONTROLLER 12V 240W SINGLE COLOUR IP20

IP67

Steps	Order No.	Model No.	Description
Step 1 - Strips	2501310730	RVA48306730	LED STRIP 12V 4.8W/M 60LED/M IP67 3000K 1M LENGTH
	2501310732	RVA48406730	LED STRIP 12V 4.8W/M 60LED/M IP67 4000K 1M LENGTH
Step 2 - Drivers	2501310733	RVA1512-PSU	LED STRIP DRIVER 12V 15W IP20 CONSTANT VOLTAGE
	2501310734	RVA3012-PSU	LED STRIP DRIVER 12V 30W IP20 CONSTANT VOLTAGE
	2501310735	RVA6012-PSU	LED STRIP DRIVER 12V 60W IP20 CONSTANT VOLTAGE
	2501310736	RVA10012-PSU	LED STRIP DRIVER 12V 100W IP20 CONSTANT VOLTAGE
Step 3 - Connectors	2501310741	RVA67-C	LED STRIP CLIP CONNECTOR STRIP-STRIP NO LEAD IP67
	2501310742	RVA67-C1	LED STRIP CLIP CONNECTOR STRIP-DRIVER 150MM LEAD IP67
	2501310743	RVA67-C2	LED STRIP CLIP CONNECTOR STRIP-STRIP 150MM LEAD IP67
	2501310744	RVA67-EC	LED STRIP 5 END CAPS & 10 CLIPS IP67
	2501310745	RVA67-G	LED STRIP GLUE FOR IP67 CONNECTORS
	2501310746	RVA67-H	LED STRIP HEAT SHRINK FOR IP67 CONNECTORS
Step 4 - WiFi controller	2501310747	RVACCT1-WIFI	LED STRIP WIFI CONTROLLER 12V 240W SINGLE COLOUR IP20

LED Link Lights

A range of colour changing LED link lights changeable between 3000k and 4000k. Available in a range of sizes that are fully linkable, providing maximum flexibility.



Material construction

- Polycarbonate body - white RAL9016
- Opal polycarbonate diffuser



Linkable with the use of various length link leads



Under cabinet or wall mountable



How does it work? A switch on the side of the fitting allows colour change between 3000K & 4000K during and after install



Order No.	Model No.	Description	Wattage (W)	Lumens (lm)	Efficacy (Lm/W)	Colour Temperature (K)
2501120838	RLEDSTR3X-01	COLOUR CHANGE UNDERCABINET LINK LIGHT 275MM	3	380	126	3000 & 4000
2501120839	RLEDSTR4X-01	COLOUR CHANGE UNDERCABINET LINK LIGHT 395MM	4	520	130	3000 & 4000
2501120840	RLEDSTR8X-01	COLOUR CHANGE UNDERCABINET LINK LIGHT 520MM	8	800	100	3000 & 4000
2501120841	RLEDSTR14X-01	COLOUR CHANGE UNDERCABINET LINK LIGHT 815MM	14	1570	112	3000 & 4000

Accessories

2501120842	RLSTR250LEAD	250MM LINK LIGHT LEAD
2501120843	RLSTR500LEAD	500MM LINK LIGHT LEAD
2501120844	RLSTR1000LEAD	1000MM LINK LIGHT LEAD

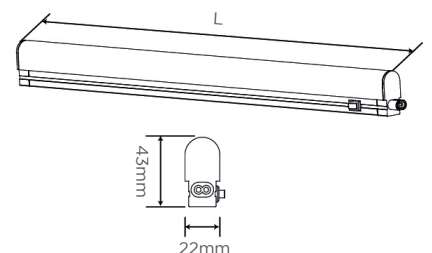

Model	Watts	L	Max no. can be connected
RLEDSTR3X-01	3W	275MM	15
RLEDSTR4X-01	4W	395MM	15
RLEDSTR8X-01	8W	520MM	15
RLEDSTR14X-01	14W	815MM	12

LED Undercabinet Lights

A range of LED mains voltage cabinet lights available in 3000K and 4000K which provide a modern and sleek look to any installation.



Materials construction

- Polycarbonate body
- Polycarbonate bezel - satin chrome
- Polycarbonate diffuser



Surface or recessed mountable



100° beam angle



Circular or Triangular fittings available



Order No.	Model No.	Description	Wattage (W)	Lumens (lm)	Efficacy (Lm/W)	Colour Temperature (K)
2501120845	RCD2P530-13	LED CIRCULAR CABINET LIGHT	2.5	190	76	3000
2501120846	RCD2P540-13	LED CIRCULAR CABINET LIGHT	2.5	210	87	4000
2501120847	RYA2P530-13	LED TRIANGULAR CABINET LIGHT	2.5	190	76	3000
2501120848	RYA2P540-13	LED TRIANGULAR CABINET LIGHT	2.5	210	87	4000

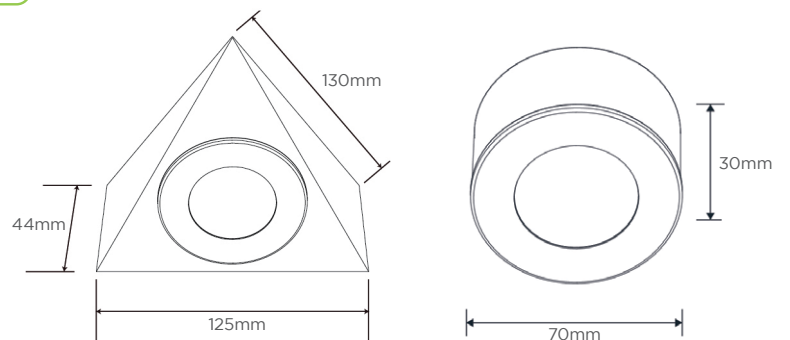

LED Shaverlight

This stylish LED shaver light is suitable for all bathroom lighting applications, providing a power outlet to allow for charging and electrical usage. This is a multi-usage fitting that can easily be installed in new or retrofit installations.



Material construction

- Polycarbonate body - white
- Opal polycarbonate diffuser



Complete with 110v/240v shaver power and charging output



Available in white and chrome finish



Pull cord switch for easy usage



Order No.	Model No.	Description	Wattage (W)	Lumens (lm)	Efficacy (Lm/W)	Colour Temperature (K)
2501182954	RSH7LED-01	WHITE SHAVER LIGHT	7	410	59	4000K
2501182955	RSH7LED-03	CHROME SHAVER LIGHT	7	410	59	4000K

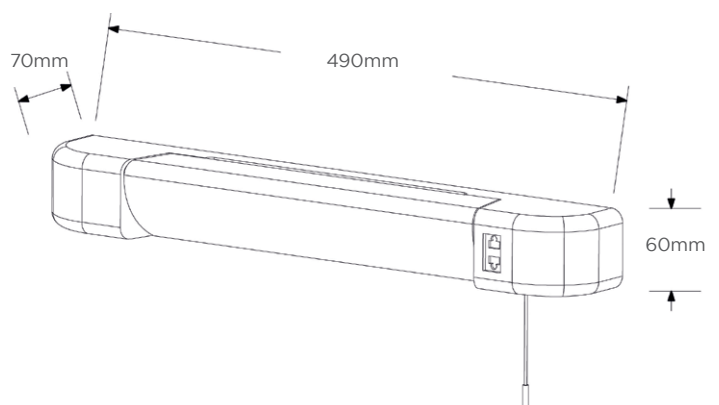

Site Supplies

Quality and safety for every project



**Site Equipment /
Consumables**



PPE



Tools

We have everything you need to keep your site compliant and running efficiently and safely.

Ask us about our added value services: facefit testing, gloves trials and Site Safety Toolbox talks.

Order online or via any branch for fast collection or free delivery nationwide.

SITE EQUIPMENT CONSUMABLES PPE TOOLS

REXEL.CO.UK







a world of energy

Lamps



LED GLS

The LED GLS range provides energy efficient direct replacements for the 40W and 60W standard halogen lamps. Available in warm white suitable for almost every type of living space.

-  Easy retrofit for traditional halogen lamps
-  Standard and dimmable options available
-  Wide beam angle ideal for general area lighting
-  Over 115 Lumens per Circuit Watt



Order No.	Model No.	Description	Halogen equivalent (W)	Wattage (W)	Lumens (lm)	Efficacy (Lm/W)	Colour Temperature (K)
2501189711	CLASSIC A40 B22 827	LED GLS A40 FROSTED B22	40	4	470	118	2700
2501001523	NLGLS4727E27	LED GLS A40 FROSTED E27	40	4	470	118	2700
2501189712	CLASSIC A60 B22 827	LED GLS A60 FROSTED B22	60	7	806	115	2700
2501189713	CLASSIC A60 E27 827	LED GLS A60 FROSTED E27	60	7	806	115	2700
2501189714	DIM CLASSIC A60 B22 827	LED GLS A60 FROSTED B22 DIMMABLE	60	7.5	806	107	2700
2501001527	DIM CLASSIC A60 E27 827	LED GLS A60 FROSTED DIMMABLE	60	7	806	115	2700



CorePro LED Frosted GLS Non Dimmable

PHILIPS

Our CorePro LED frosted GLS lamps are designed with quality in mind for everyday installations. Available in a 40w, 60w, 75w & 100w tungsten halogen equivalent, and non-dimmable as standard. Colour temperatures of 2700k (Very Warm White) & 4000k (Cool White - ES/E27 cap) to suit a wide variety of applications.



Market leading Philips quality LED lamps



ES/E27 & BC/B22 cap versions available



Non-Dimmable as standard (Dimmable available in the Master Value range)



Order No.	Model No.	Description	Cap Type	Halogen Equivalent (W)	Wattage (W)	Lumens (lm)	Efficacy (Lm/W)	Colour Temperature (K)
2500931318	929001234299	FROSTED GLS BULB 5.5W (40W EQUIV) E27 827 NON-DIMMABLE	ES (E27)	40	5.5	470	85	2700K
2500931319	929001233899	FROSTED GLS BULB 5.5W (40W EQUIV) B22 827 NON-DIMMABLE	BC (B22)	40	5.5	470	85	2700K
2500931321	929001234385	FROSTED GLS BULB 8W (60W EQUIV) E27 827 NON-DIMMABLE	ES (E27)	60	8	806	101	2700K
2500931322	929001233997	FROSTED GLS BULB 8W (60W EQUIV) B22 827 NON-DIMMABLE	BC (B22)	60	8	806	101	2700K
2500931324	929001234402	FROSTED GLS BULB 11W (75W EQUIV) E27 827 NON-DIMMABLE	ES (E27)	75	11	1055	96	2700K
2500931325	929001234098	FROSTED GLS BULB 11W (75W EQUIV) B22 827 NON-DIMMABLE	BC (B22)	75	11	1055	96	2700K
2500826592	929001234564	FROSTED GLS BULB 13W (100W EQUIV) E27 827 NON-DIMMABLE	ES (E27)	100	13	1521	117	2700K
2500826591	929001234199	FROSTED GLS BULB 13W (100W EQUIV) B22 827 NON-DIMMABLE	BC (B22)	100	13	1521	117	2700K
2500931320	929001234602	FROSTED GLS BULB 5W (40W EQUIV) E27 840 NON-DIMMABLE	ES (E27)	40	5	470	94	4000K
2500931323	929001234702	FROSTED GLS BULB 7.5W (60W EQUIV) E27 840 NON-DIMMABLE	ES (E27)	60	7.5	806	107	4000K
2500931326	929001234802	FROSTED GLS BULB 10W (75W EQUIV) E27 840 NON-DIMMABLE	ES (E27)	75	10	1055	106	4000K
2501016881	929001312402	FROSTED GLS BULB 12.5W (100W EQUIV) E27 840 NON-DIMMABLE	ES (E27)	100	12.5	1521	122	4000K



Master Value LED Frosted GLS Dimmable

PHILIPS

Our Master Value LED frosted lamps offer fantastic light quality and efficiency, with a CRI of 90+ truly bringing colours to life. Available in a 40w, 60w, 75w and 100w tungsten halogen equivalent, and dimmable as standard with a colour temperature of 2700k (Very warm white)



Market leading Philips quality LED lamps with a 5 year warranty



ES/E27 & BC/B22 cap versions available



Dimmable as standard



Order No.	Model No.	Description	Cap Type	Halogen Equivalent (W)	Wattage (W)	Lumens (lm)	Efficacy (Lm/W)	Colour Temperature (K)	
2501423460	929003070702	FROSTED GLS BULB 3.4W (40W EQUIV) E27 927 DIMMABLE	ES (E27)	40	3.4	470	138	2700K	*
2501423461	929003010202	FROSTED GLS BULB 3.4W (40W EQUIV) B22 927 DIMMABLE	BC (B22)	40	3.4	470	138	2700K	*
2501423462	929003057799	FROSTED GLS BULB 5.9W (60W EQUIV) E27 927 DIMMABLE	ES (E27)	60	5.9	806	137	2700K	*
2501423463	929003010699	FROSTED GLS BULB 5.9W (60W EQUIV) B22 927 DIMMABLE	BC (B22)	60	5.9	806	137	2700K	*
2501423464	929003058102	FROSTED GLS BULB 7.8W (75W EQUIV) E27 927 DIMMABLE	ES (E27)	75	7.8	1055	135	2700K	*
2501423465	929003011402	FROSTED GLS BULB 7.2W (75W EQUIV) B22 927 DIMMABLE	BC (B22)	75	7.2	1055	147	2700K	*
2501423466	929003058502	FROSTED GLS BULB 11.2W (100W EQUIV) E27 927 DIMMABLE	ES (E27)	100	11.2	1521	136	2700K	*
2501423467	929003011899	FROSTED GLS BULB 10.5W (100W EQUIV) B22 927 DIMMABLE	BC (B22)	100	10.5	1521	145	2700K	*



***AVAILABLE NOVEMBER 2021.
ALTERNATIVES AVAILABLE.**

Master Value LED Filament GLS Dimtone

PHILIPS

Our striking Master Value LED filament lamps offer superb light quality and efficiency, with a CRI of 90+ truly bringing colours to life. Available in a 40w & 60w tungsten halogen equivalent, and DimTone as standard. Colour temperature of 2700k (Very Warm White) which gets warmer (down to 2200k) the more you dim the lamp, giving a true halogen lit effect with LED efficiency.



Market leading Philips quality LED lamps with a 5 year warranty



ES/E27 & BC/B22 cap versions available



DimTone means the colour temperature gets warmer as you dim



Order No.	Model No.	Description	Cap Type	Halogen Equivalent (W)	Wattage (W)	Lumens (lm)	Efficacy (Lm/W)	Colour Temperature (K)
2501346770	929003009902	CLEAR FILAMENT GLS BULB 3.4W (40W EQUIV) E27 DIMTONE	ES (E27)	40	3.4	470	138	2700 - 2200K DIMTONE
2501346781	929003010199	CLEAR FILAMENT GLS BULB 3.4W (40W EQUIV) B22 DIMTONE	BC (B22)	40	3.4	470	138	2700 - 2200K DIMTONE
2501346792	929003010398	CLEAR FILAMENT GLS BULB 5.9W (60W EQUIV) E27 DIMTONE	ES (E27)	60	5.9	806	137	2700 - 2200K DIMTONE
2501346803	929003010598	CLEAR FILAMENT GLS BULB 5.9W (60W EQUIV) B22 DIMTONE	BC (B22)	60	5.9	806	137	2700 - 2200K DIMTONE



Master LED GLS Dimtone

PHILIPS

Our market leading Master LED GLS lamps offer superb light quality and efficiency, with a CRI of 90+ truly bringing colours to life. Available in a 40w & 60w tungsten halogen equivalent, and DimTone as standard. Colour temperatures of 2700k (Very Warm White) which gets warmer (down to 2200k) the more you dim the lamp, giving a true halogen lit effect with LED efficiency.



Market leading Philips quality LED lamps with a 5 year warranty



ES/E27 & BC/B22 cap versions available



DimTone means the colour temperature gets warmer as you dim







Order No.	Model No.	Description	Cap Type	Halogen Equivalent (W)	Wattage (W)	Lumens (lm)	Efficacy (Lm/W)	Colour Temperature (K)
2500826598	929002490002	CLEAR GLS BULB 5.5W (40W EQUIV) E27 DIMTONE	ES (E27)	40	5.5	470	85	2700 - 2200K DIMTONE
2500826597	929002490102	CLEAR GLS BULB 5.5W (40W EQUIV) B22 DIMTONE	BC (B22)	40	5.5	470	85	2700 - 2200K DIMTONE
2500826600	929002490299	CLEAR GLS BULB 8W (60W EQUIV) E27 DIMTONE	ES (E27)	60	8	806	101	2700 - 2200K DIMTONE
2500826599	929002490399	CLEAR GLS BULB 8W (60W EQUIV) B22 DIMTONE	BC (B22)	60	8	806	101	2700 - 2200K DIMTONE



LED Candle

The LED candle range provides energy efficient direct replacements for the 40W standard halogen lamp. Available in warm white suitable for almost every type of living space.

-  Easy retrofit for traditional halogen lamps
-  Standard and dimmable options available
-  Wide beam angle ideal for general area lighting
-  Over 94 Lumens per Circuit Watt



Order No.	Model No.	Description	Halogen Equivalent (W)	Wattage (W)	Lumens (lm)	Efficacy (Lm/W)	Colour Temperature (K)
2501189715	CLASSIC B40 E14 827	LED CANDLE FROSTED E14	40	4	470	118	2700
2501001529	NLC4727B22	LED CANDLE FROSTED B22	40	4	470	118	2700
2501001530	NLC4727E14D	LED CANDLE FROSTED E14 DIMMABLE	40	5	470	94	2700
2501001531	NLC4727B22D	LED CANDLE FROSTED B22 DIMMABLE	40	5	470	94	2700



CorePro LED Filament Candle Non Dimmable

PHILIPS

Our CorePro LED filament candles are designed with quality in mind for everyday installations. Available in a 25w, 40w & 60w tungsten halogen equivalent. Non-dimmable as standard (dimmable versions available in Master Value) and a colour temperature of 2700k (Very Warm White).



Market leading Philips quality LED lamps



SES/E14 & BC/B22 cap versions available



Non-Dimmable as standard (Dimmable available in the Master Value range)



Curly Tip 'Flame' Version

'Twirl' Version

Order No.	Model No.	Description	Cap Type	Halogen Equivalent (W)	Wattage (W)	Lumens (lm)	Efficacy (Lm/W)	Colour Temperature (K)
2501423468	929001238392	PHILIPS COREPRO CLEAR FILAMENT CANDLE 2W (EQUIV TO 25W) E14 827 NON-DIMMABLE	SES (E14)	25	2	250	125	2700K *
2501016728	929001238492	PHILIPS COREPRO CLEAR FILAMENT CANDLE 2W (EQUIV TO 25W) E14 827 CURLY TIP NON-DIMMABLE	SES (E14)	25	2	250	125	2700K
2501016729	929001238592	PHILIPS COREPRO CLEAR FILAMENT CANDLE 2W (EQUIV TO 25W) E14 827 'TWIRL' NON-DIMMABLE	SES (E14)	25	2	250	125	2700K
2501016731	929001815692	PHILIPS COREPRO VALUE CLEAR FILAMENT CANDLE 2W (EQUIV TO 25W) B22 827 NON-DIMMABLE	BC (B22)	25	2	250	125	2700K
2501423469	929001889719	PHILIPS COREPRO CLEAR FILAMENT CANDLE 4.3W (EQUIV TO 40W) E14 827 NON-DIMMABLE	SES (E14)	40	4.3	470	109	2700K *
2501166340	929002028092	PHILIPS COREPRO CLEAR FILAMENT CANDLE 6.5W (EQUIV TO 60W) E14 827 NON-DIMMABLE	SES (E14)	60	6.5	806	124	2700K



***AVAILABLE NOVEMBER 2021. ALTERNATIVES AVAILABLE.**

Master LED Candle DimTone

PHILIPS

Our market leading Master LED candles offer superb light quality and efficiency, with a CRI of 90+ truly bringing colours to life. Available in a 25w, 40w & 60w tungsten halogen equivalent, in a variety of cap types and DimTone as standard. Colour temperature of 2700k (Very Warm White) which gets warmer (down to 2200k) the more you dim the lamp, giving a true halogen lit effect with LED efficiency.

- ✓ Market leading Philips quality LED lamps
- 👍 Various cap types available
- ✓ DimTone as standard



Curly Tip 'Flame'
Version

Order No.	Model No.	Description	Cap Type	Halogen Equivalent (W)	Wattage (W)	Lumens (lm)	Efficacy (Lm/W)	Colour Temperature (K)
2500799365	929002490402	CLEAR CANDLE 2.8W (EQUIV TO 25W) E14 DIMTONE	SES (E14)	25	2.8	250	89	2700K - 2200K DIMTONE
2500799366	929002490602	CLEAR CANDLE 2.8W (EQUIV TO 25W) E14 CURLY TIP 'FLAME' DIMTONE	SES (E14)	25	2.8	250	89	2700K - 2200K DIMTONE
250106719	929002490502	CLEAR CANDLE 2.8W (EQUIV TO 25W) B22 DIMTONE	BC (B22)	25	2.8	250	89	2700K - 2200K DIMTONE
2500799384	929002491099	CLEAR CANDLE 5.5W (EQUIV TO 40W) E14 DIMTONE	SES (E14)	40	5.5	470	85	2700K - 2200K DIMTONE
2500799385	929002491302	CLEAR CANDLE 5.5W (EQUIV TO 40W) E14 CURLY TIP 'FLAME' DIMTONE	SES (E14)	40	5.5	470	85	2700K - 2200K DIMTONE
2500867222	929002491299	CLEAR CANDLE 5.5W (EQUIV TO 40W) E27 DIMTONE	ES (E27)	40	5.5	470	85	2700K - 2200K DIMTONE
2500931416	929002490999	CLEAR CANDLE 5.5W (EQUIV TO 40W) B15 DIMTONE	SBC (B15)	40	5.5	470	85	2700K - 2200K DIMTONE
2500799386	929002491199	CLEAR CANDLE 5.5W (EQUIV TO 40W) B22 DIMTONE	BC (B22)	40	5.5	470	85	2700K - 2200K DIMTONE
2500931331	929002491702	CLEAR CANDLE 8W (EQUIV TO 60W) E14 DIMTONE	SES (E14)	60	8	806	101	2700K - 2200K DIMTONE



Master Value LED Filament Candle DimTone

PHILIPS

Our market leading Master Value LED filament candles offer superb light quality and efficiency, with a CRI of 90+ truly bringing colours to life. Available in a 25w & 40w tungsten halogen equivalent and DimTone as standard. Colour temperature of 2700k (Very Warm White) which gets warmer (down to 2200k) the more you dim the lamp, giving a true halogen lit effect with LED efficiency.



Market leading Philips quality LED lamps



SES/E14 cap type



DimTone as standard means the colour gets warmer as you dim



Curly Tip 'Flame' Version

Order No.	Model No.	Description	Cap Type	Halogen Equivalent (W)	Wattage (W)	Lumens (lm)	Efficacy (Lm/W)	Colour Temperature (K)
2501346809	929003011902	CLEAR FILAMENT CANDLE 2.5W (EQUIV TO 25W) E14 DIMTONE	SES (E14)	25	2.5	340	136	2700K - 2200K DIMTONE *
2501346810	929003012298	CLEAR FILAMENT CANDLE 3.4W (EQUIV TO 40W) E14 DIMTONE	SES (E14)	40	3.4	470	138	2700K - 2200K DIMTONE
2501346811	929003013002	CLEAR FILAMENT CANDLE 3.4W (EQUIV TO 40W) E14 CURLY TIP DIMTONE	SES (E14)	40	3.4	470	138	2700K - 2200K DIMTONE



***AVAILABLE DECEMBER 2021. ALTERNATIVES AVAILABLE.**

LED GU10

The LED GU10 range provides energy efficient direct replacements for 35W and 50W standard tungsten halogen lamps. Available in warm white suitable for almost every type of living space and cool white for commercial and office environments.

 Standard and dimmable options available

 Wide beam angle ideal for general area lighting

 Over 64 Lumens per Circuit Watt



Order No.	Model No.	Description	Halogen Equivalent (W)	Wattage (W)	Lumens (lm)	Efficacy (Lm/W)	Colour Temperature (K)
2501189706	PAR16 35 827	LED PAR16 35 GU10 36DEG	35	2.6	230	88	2700
2501001513	NLGU102340	LED PAR16 35 GU10 36DEG	35	2.6	230	88	4000
2501189707	PAR16 50 827	LED PAR16 50 GU10 36DEG	50	4.3	350	81	2700
2501189708	PAR16 50 840	LED PAR16 50 GU10 36DEG	50	4.3	350	81	4000
2501189709	DIM PAR16 50 827	LED PAR16 50 GU10 36DEG DIMMABLE	50	5.5	350	64	2700
2501189710	DIM PAR16 50 840	LED PAR16 50 GU10 36DEG DIMMABLE	50	5.5	350	64	4000



CorePro LED GU10

PHILIPS

Our CorePro LED GU10 lamps are designed with quality in mind for everyday installations. Available in a 35w and 50w tungsten halogen equivalent, dimmable and non-dimmable versions. Colour temperatures of 2700k (Very Warm White), 3000k (Warm White), 4000k (Cool White) & 6500K (Daylight - 50w equivalent only) to suit a wide variety of applications.

- ✓ Market leading Philips quality LED lamps
- 👍 36 Degree beam angle for general lighting applications
- ✓ Dimmable & Non-Dimmable options available
- 👍 Designed to mirror the output and lit effect of traditional halogen lamps



Order No.	Model No.	Description	Halogen Equivalent (W)	Wattage (W)	Lumens (lm)	Efficacy (Lm/W)	Colour Temperature (K)	
2501423452	929002495802	GU10 3W (35W EQUIV) 827 DIMMABLE	35	3	230	77	2700	*
2501423453	929002068299	GU10 3W (35W EQUIV) 830 DIMMABLE	35	3	230	77	3000	*
2501423454	929002065602	GU10 3W (35W EQUIV) 840 DIMMABLE	35	3	240	80	4000	*
2501423455	929002495999	GU10 4W (50W EQUIV) 827 DIMMABLE	50	4	345	86	2700	*
2501423456	929002068399	GU10 4W (50W EQUIV) 830 DIMMABLE	50	4	345	86	3000	*
2501423457	929002065899	GU10 4W (50W EQUIV) 840 DIMMABLE	50	4	345	86	4000	*
2501016793	929001217897	GU10 3.5W (35W EQUIV) 827 NON-DIMMABLE	35	3.5	255	73	2700	
2501016794	929001217999	GU10 3.5W (35W EQUIV) 830 NON-DIMMABLE	35	3.5	265	76	3000	
2501016796	929001218099	GU10 3.5W (35W EQUIV) 840 NON-DIMMABLE	35	3.5	275	79	4000	
2501016797	929001215268	GU10 4.6W (50W EQUIV) 827 NON-DIMMABLE	50	4.6	355	77	2700	
2501016798	929001218199	GU10 4.6W (50W EQUIV) 830 NON-DIMMABLE	50	4.6	370	80	3000	
2501016799	929001218299	GU10 4.6W (50W EQUIV) 840 NON-DIMMABLE	50	4.6	390	85	4000	
2501016800	929001218399	GU10 4.6W (50W EQUIV) 865 NON-DIMMABLE	50	4.6	390	85	6500	



***AVAILABLE NOVEMBER 2021.
ALTERNATIVES AVAILABLE.**

Master Value LED GU10

PHILIPS

Our market leading Master Value LED GU10 lamps are the next step up in light quality and efficiency, with a CRI of 90+ truly bringing colours to life. Available in a 35w, 50w & 80w tungsten halogen equivalent, dimmable and non-dimmable versions. Colour temperatures of 2700k (Very Warm White), 3000k (Warm White), 4000k (Cool White) & 6500k (Daylight - 80w equivalent only) to suit a wide variety of applications.

- ✓ Market leading Philips quality LED lamps with a 5 year warranty
- 👍 36 Degree beam angle for general lighting applications
- ✓ Dimmable & Non-Dimmable options available
- ✓ DimTone versions of 35w and 50w lamp means the colour gets warmer as you dim



Order No.	Model No.	Description	Halogen Equivalent (W)	Wattage (W)	Lumens (lm)	Efficacy (Lm/W)	Colour Temperature (K)
2501423458	929002979702	GU10 3.7W (35W EQUIV) 927 DIMTONE	35	3.7	270	73	2700 - 2200K DIMTONE *
2501423459	929002979402	GU10 3.7W (35W EQUIV) 927 DIMMABLE	35	3.7	270	73	2700K *
2501016806	929001348302	GU10 3.7W (35W EQUIV) 930 DIMMABLE	35	3.7	270	73	3000K
2501016817	929001348402	GU10 3.7W (35W EQUIV) 940 DIMMABLE	35	3.7	285	77	4000K
2501016828	929001350399	GU10 4.9W (50W EQUIV) 927 DIMTONE	50	4.9	395	81	2700 - 2200K DIMTONE
2501016839	929002980102	GU10 4.8W (50W EQUIV) 927 DIMMABLE	50	4.8	360	75	2700K
2501016850	929001348998	GU10 4.9W (50W EQUIV) 930 DIMMABLE	50	4.9	365	74	3000K
2501016861	929001349099	GU10 4.9W (50W EQUIV) 940 DIMMABLE	50	4.9	380	78	4000K
2501166319	929002059599	GU10 6.2W (80W EQUIV) 927 DIMMABLE	80	6.2	650	105	2700K
2501166290	929002068499	GU10 6.2W (80W EQUIV) 930 DIMMABLE	80	6.2	680	105	3000K
2501166308	929002066099	GU10 6.2W (80W EQUIV) 940 DIMMABLE	80	6.2	680	110	4000K
2501166330	929002209999	GU10 6.2W (80W EQUIV) 965 DIMMABLE	80	6.2	680	110	6500K



***AVAILABLE NOVEMBER 2021.
ALTERNATIVES AVAILABLE.**

LED MR16

The LED MR16 range provides energy efficient direct replacements for standard halogen lamps. Available in warm white suitable for almost every type of living space and cool white for commercial and office environments.

- ✓ Easy retrofit for traditional halogen lamps
- ⤵ Standard and dimmable options available
- ⤴ Wide beam angle ideal for general area lighting
- ☀ Over 68 Lumens per Circuit Watt



Order No.	Model No.	Description	Halogen Equivalent (W)	Wattage (W)	Lumens (lm)	Efficacy (Lm/W)	Colour Temperature (K)
2501001518	MR16 20 827	LED MR16 20 36DEG	20	2.9	230	79	2700
2501001519	MR16 20 840	LED MR16 20 36DEG	20	2.9	230	79	4000
2501192247	DIM MR16 20 827	LED MR16 20 36DEG DIMMABLE	20	3.4	230	68	2700
2501001521	DIM MR16 20 840	LED MR16 20 36DEG DIMMABLE	20	3.4	230	68	4000



CorePro LED MR16 Non Dimmable

PHILIPS

Our CorePro MR16 LED is perfect for every day applications where dimming is not required. Available in a 35w equivalent in 2700k (Very Warm White) and 4000k (Cool White). We also offer a wider range such as 50w equivalents (check online for further information) and dimmable versions on the next page as part of our Master Value MR16 range.



Market leading Philips quality every day LED lamps



36 Degree beam angle for general lighting applications



Non-Dimmable (Dimmable available in Master Value on next page)



Order No.	Model No.	Description	Halogen Equivalent (W)	Wattage (W)	Lumens (lm)	Efficacy (Lm/W)	Colour Temperature (K)
2501016827	929002494699	MR16 4.4W (35W EQUIV) 827 NON DIMMABLE	35	4.4	345	78	2700K
2501016829	929002494799	MR16 4.4W (35W EQUIV) 840 NON DIMMABLE	35	4.4	390	89	4000K



Master Value LED MR16 Dimmable

Our market leading Master Value LED GU10 lamps are the next step up in light quality and efficiency, with a CRI of 90+ truly bringing colours to life. Available in a 35w, 50w & 80w tungsten halogen equivalent, dimmable and non-dimmable versions. Colour temperatures of 2700k (Very Warm White), 3000k (Warm White), 4000k (Cool White) & 6500k (Daylight - 80w equivalent only) to suit a wide variety of applications.

- ✓ Market leading Philips quality LED lamps with a 5 year warranty
- 👍 36 Degree beam angle for general lighting applications
- ✓ Dimmable as standard





Order No.	Model No.	Description	Halogen Equivalent (W)	Wattage (W)	Lumens (lm)	Efficacy (Lm/W)	Colour Temperature (K)
2501016821	929002492502	MR16 5.8W (35W EQUIV) 927 DIMMABLE	35	5.8	450	78	2700k
2501016822	929002492602	MR16 5.8W (35W EQUIV) 930 DIMMABLE	35	5.8	460	79	3000k
2501016823	929002492702	MR16 5.8W (35W EQUIV) 940 DIMMABLE	35	5.8	490	84	4000k
2501119835	929002493202	MR16 7.5W (50W EQUIV) 927 DIMMABLE	50	7.5	621	83	2700k
2501119846	929002493302	MR16 7.5W (50W EQUIV) 930 DIMMABLE	50	7.5	630	84	3000k
2501119857	929002493402	MR16 7.5W (50W EQUIV) 940 DIMMABLE	50	7.5	660	88	4000k



LED G4 G9

The LED G4/G9 range provides energy efficient direct replacements for 20W standard halogen lamps. Available in warm white suitable for almost every type of living space.

-  Easy retrofit for traditional halogen lamps
-  Wide beam angle ideal for general area lighting
-  Over 105 Lumens per Circuit Watt

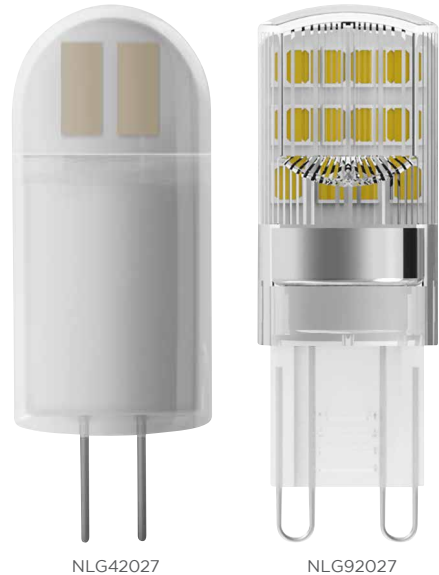



Order No.	Model No.	Description	Halogen Equivalent (W)	Wattage (W)	Lumens (lm)	Efficacy (Lm/W)	Colour Temperature (K)
2501001532	NLG42027	LED CAPSULE G4	20	1.8	200	111	2700
2501189716	PIN 20 G9 2700	LED CAPSULE G9	20	1.9	200	105	2700



LED T8 Tubes

The LED T8 tube range provides energy efficient direct replacements for T8 fluorescent tubes. Available in cool white or daylight colour temperatures with the added safety feature of a polycarbonate construction to prevent shattering.

- 
 Switch start retrofit - simply replace starter with one provided
- 
 HF retrofit - to achieve energy savings control gear must be bypassed and wired directly to mains
- 
 Over 100 Lumens per Circuit Watt



Order No.	Model No.	Description	Halogen Equivalent (W)	Wattage (W)	Lumens (lm)	Efficacy (Lm/W)	Colour Temperature (K)
2501001534	ST8SP-0.6M-840	LED 2FT T8 POLYCARBONATE TUBE	18	7.6	800	105	4000
2501001535	ST8SP-1.2M-840	LED 4FT T8 POLYCARBONATE TUBE	36	16	1700	106	4000
2501001536	ST8SP-1.5M-840	LED 5FT T8 POLYCARBONATE TUBE	58	20	2000	100	4000
2501001537	ST8SP-1.8M-840	LED 6FT T8 POLYCARBONATE TUBE	70	24	2600	108	4000
2501001538	NLT88065	LED 2FT T8 POLYCARBONATE TUBE	18	7.6	800	105	6500
2501001539	NLT81765	LED 4FT T8 POLYCARBONATE TUBE	36	16	1700	106	6500
2501001540	ST8SP-1.5M-865	LED 5FT T8 POLYCARBONATE TUBE	58	20	2000	100	6500
2501001541	ST8SP-1.8M-865	LED 6FT T8 POLYCARBONATE TUBE	70	24	2600	108	6500



CorePro LED Tube

PHILIPS

Our CorePro LED Tubes are designed with quality in mind for everyday installations. Available in 4ft, 5ft and 6ft fluorescent equivalents. Offered in a colour temperature of either 4000k (Cool White) or 6500k (Daylight).



Market leading Philips quality LED tubes



2ft, 4ft, 5ft and 6ft versions available in 4000k and 6500k

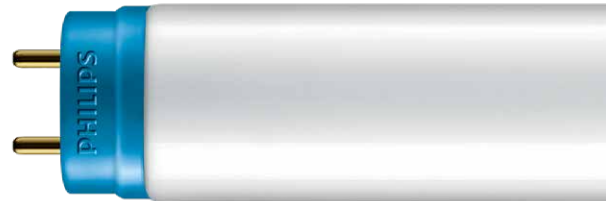

Order No.	Model No.	Description	Size	Fluorescent Equivalent (W)	Wattage (W)	Lumens (lm)	Efficacy (Lm/W)	Colour Temperature (K)
2500996888	929003022102	LED TUBE 2FT 600MM 8W 840	2FT / 600MM	18	8	800	100	4000k
2500996889	929003022202	LED TUBE 2FT 600MM 8W 865	2FT / 600MM	18	8	800	100	6500k
2500996890	929003022302	LED TUBE 4FT 1200MM 14.5W 840	4FT / 1200MM	36	14.5	1600	110	4000k
2500996891	929003022402	LED TUBE 4FT 1200MM 14.5W 865	4FT / 1200MM	36	14.5	1600	110	6500k
2500996892	929003022502	LED TUBE 5FT 1500MM 20W 840	5FT / 1500MM	58	20	2200	110	4000k
2500996893	929003022602	LED TUBE 5FT 1500MM 20W 865	5FT / 1500MM	58	20	2200	110	6500k
2501379300	929002998802	LED TUBE 6FT 1800MM 21W 840	6FT / 1800MM	70	21	3100	148	4000k



FM EXPERTISE YOU CAN TRUST



Rexel's specialist FM Team understands your sector providing expertise, quality products and innovative solutions you can trust. Locally, regionally and nationally you can trust Rexel to help you provide a rapid response, whatever sector you service.

Contact your local branch or go to rexel.co.uk

EXPERTISE QUALITY RELIABILITY INNOVATION

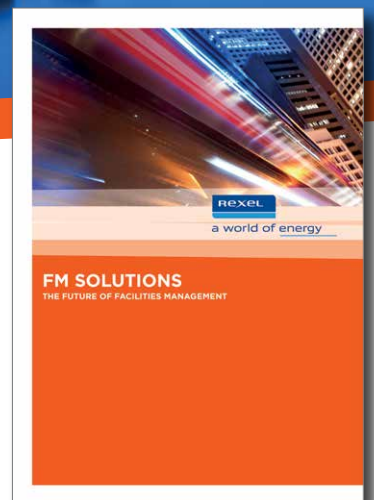

REXEL.CO.UK

REXEL

a world of energy

FM CONTACT CENTRE

Tel: 0330 045 0606

Email: customer.connect@rexel.co.uk

LED Smart Lamps

Why upgrade to smart lamps?

Convenient

- Control lights with your voice
- Automate your lights into groups with programs
- Controllable from anywhere (via gateway with internet connection)

Easy

- Installation in seconds
- Compatible with major systems through Zigbee 3.0 or Bluetooth



ZB CLA60 RGBW FR B22

What are the different ways to control the smart lamps?

- Voice control
- App control
- Switch control

What types of smart lamps are available?

- Dimmable
 - Lamp can be dimmed from 100%-3%
- Tunable White
 - The colour temperature of the lamp can be changed from daylight (6,500k) through to warm white (2,700k)
- RGB+W
 - Multicolour selection (by mixing red, green, blue) and tuneable white



ZB CLA60 RGBW FR E27



ZB CLB40 TW FR E14



ZB CLB40 DIM FR E14



ZB PAR16 RGBW/ MCOLOR



ZB PAR16 DIM 827

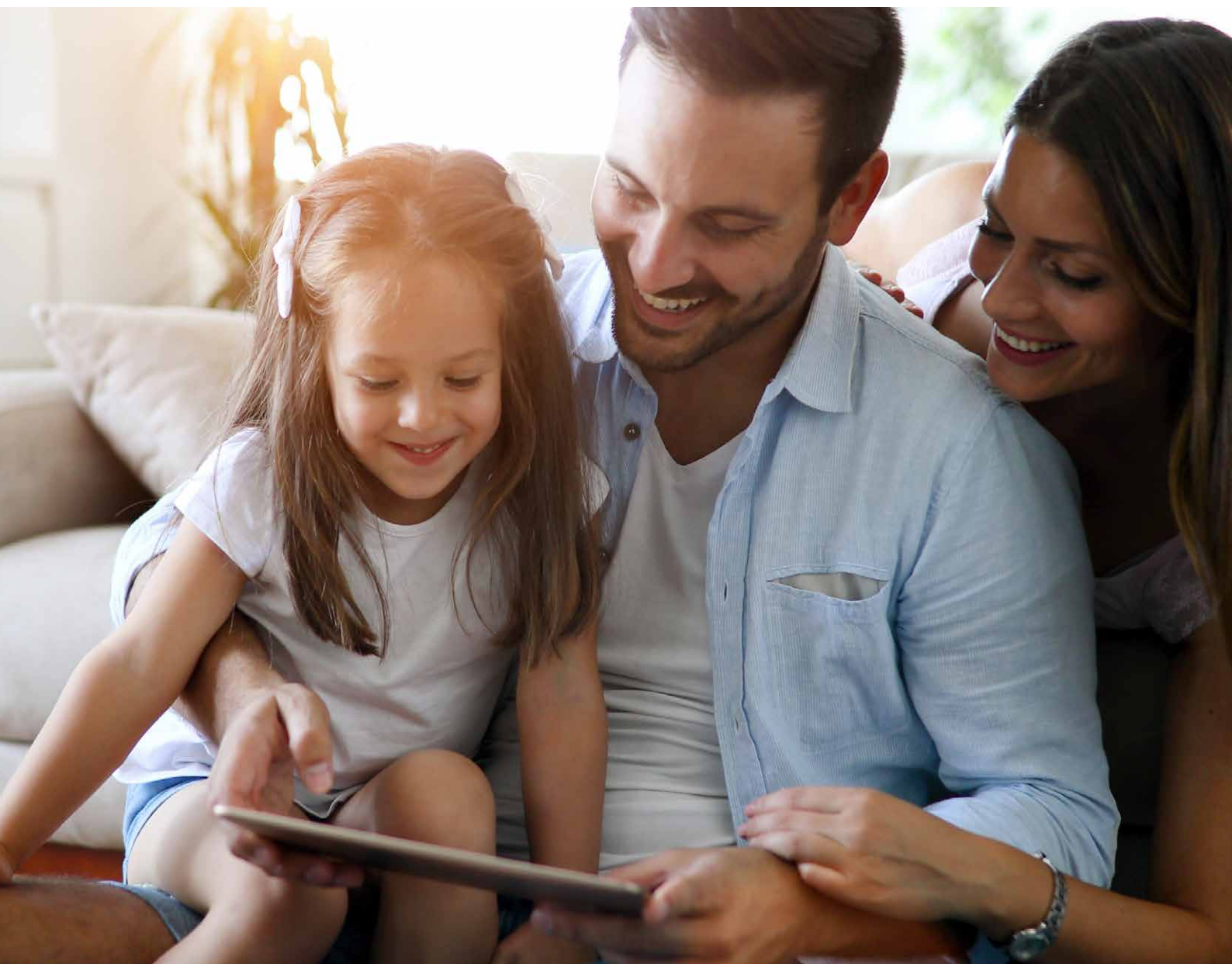

Order No.	Model No.	Description	Protocol	Smart Type	Colour Temperature (K)	Dimmable	Halogen Equivalent (W)	Wattage (W)	Lumens (lm)	Efficiency (Lm/W)
2501190223	ZB CLA60 RGBW FR E27	230V E27 GLS	Zigbee 3.0	RGB+W	MULTICOLOUR	100-3%	60	10	800	80
2501190224	ZB CLA60 RGBW FR B22	230V B22D GLS	Zigbee 3.0	RGB+W	MULTICOLOUR	100-3%	60	10	800	80
2501190225	ZB CLB40 DIM FR E14	230V E14 CANDLE	Zigbee 3.0	DIM ONLY	2700	100-3%	40	6	470	78
2501190226	ZB CLB40 TW FR E14	230V E14 CANDLE	Zigbee 3.0	TUNEABLE W	2,700-6,500	100-3%	40	6	470	78
2501190227	ZB PAR16 DIM 827	230V GU10	Zigbee 3.0	DIM ONLY	2700	100-3%	50	4.5	350	78
2501190228	ZB PAR16 RGBW/ MCOLOR	230V GU10	Zigbee 3.0	RGB+W	MULTICOLOUR	100-3%	50	5.5	350	64
2501311886	BT CLA60 RGBW/MCOLOR E27	230V E27 GLS FROSTED	Bluetooth	RGB+W	MULTICOLOUR	100-3%	60	10	800	64
2501311887	BT CLA60 RGBW/MCOLOR B22	230V B22D GLS FROSTED	Bluetooth	RGB+W	MULTICOLOUR	100-3%	60	10	800	64
2501311888	BT CLA60 DIM FR E27	230V E27 GLS FROSTED DIM	Bluetooth	DIM ONLY	2700	100-3%	60	9	800	64
2501311889	BT CLA60 FIL DIM CL E27	230V E27 GLS CLEAR DIM	Bluetooth	DIM ONLY	2700	100-3%	60	6.5	800	64

Lighting Controls



Stand Alone PIR

A standalone PIR range designed for external usage only on residential properties. They offer energy efficiency by reducing light usage while also offering security.



Day and night or night only operation



Lens can be masked to reduce nuisance detection



Adjustable time from 5 seconds to 5 minutes



Adjustable lens angle to optimise detection zone



Manual override functions available



Order No.	Model No.	Colour	Detections Angle	LED Switching Capacity (W)	Rating	Manual Override
1050378531	NLPIRB1A	BLACK	140°	100	IP44	SEPARATE SWITCH
1050378532	NLPIRW1A	WHITE	140°	100	IP44	SEPARATE SWITCH
1050378533	NLPIRB2A	BLACK	180°	100	IP55	EXISTING SWITCH
1050378534	NLPIRW2A	WHITE	180°	100	IP55	EXISTING SWITCH

CLASS
2

CE

Photocells

A range of light operated switches that switch the supply ON to a luminaire when the light level falls under a pre-set value (usually Dusk) and switches the supply OFF when it rises above a pre-set level (usually Dawn). Photocells help to drive down costs and improve energy efficiencies by ensuring lights are not on when not needed.

 UV stabilised polycarbonate construction

 Photocell Kit includes; Photocell, NEMA socket, gasket, wall mounting bracket and fixing screws

 Operating voltage 198-264V 50 Hz

NL5605

 Heavy duty load switching capacity and surge suppression



Order No.	Model No.	Description	Max Load LED	Switch on/off light level (lux)	Sensor	Switching Operations	Operating Temperatures
1000005886	NL5600	PHOTOCELL	1000W (4A)	70/105	Photodiode	10000	-20°C to + 70°C
1000015760	NL5601	PHOTOCELL KIT	1000W (4A)	70/105	Photodiode	10000	-20°C to + 70°C
1050150455	NL5605	SURGE SUPRESSED PHOTOCELL KIT	1500W (6A)	70/35	PhotoIC	25000	-20°C to + 80°C

Miniature Photocells

A range of light operated switches that switch the supply ON to a luminaire when the light level falls under a pre-set value (usually Dusk) and switches the supply OFF when it rises above a pre-set level (usually Dawn). Photocells help to drive down costs and improve energy efficiencies by ensuring lights are not on when not needed.

 Consumes less than 0.25W (Day & Night)

 IP65 when installed correctly

NL5608

 20mm Sensor/mounting stud

NLSS14R

 20mm remote sensor

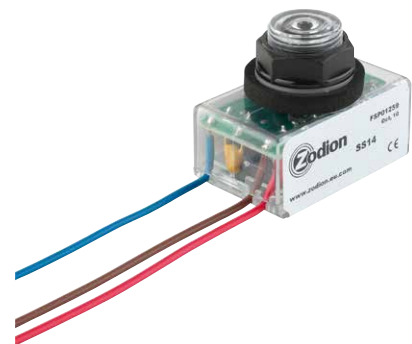

Order No.	Model No.	Description	Surge Suppressed	Max Load LED	Switch on/off light level (lux)	Sensor	Switching Operations	Operating Temperatures
1050334793	NL5608	MINI PHOTOCELL		1000W (4A)	70/105	Photodiode	10000	-20°C to + 75°C
1051059427	NLSS14R	MINI REMOTE PHOTOCELL	•	1000W (4A)	70/105	Photodiode	10000	-20°C to + 75°C

Register now to take full advantage of our time-saving features!

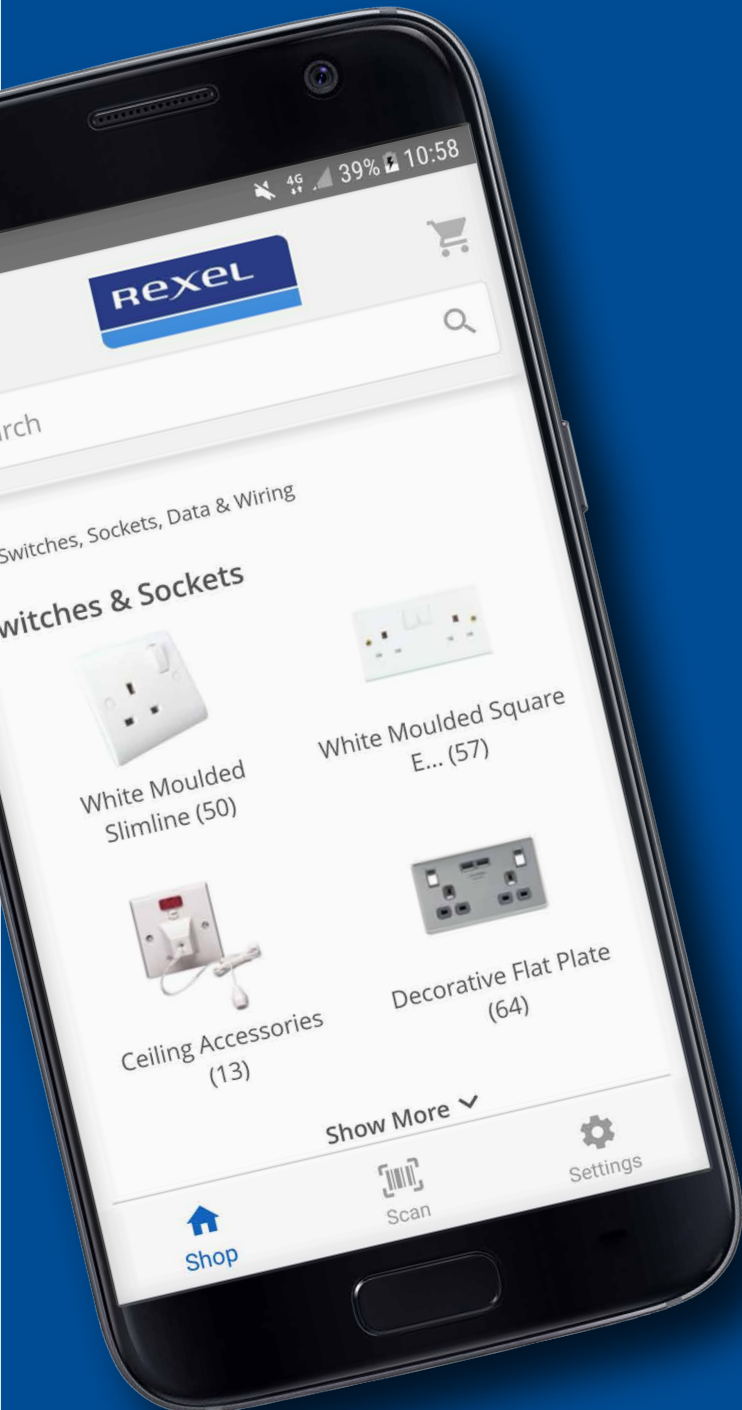

- ✓ 350,000 products online
- ✓ View live stock across UK
- ✓ Easy search via 'already bought'
- ✓ Click and collect from 200+ branches
- ✓ Free next day delivery*
- ✓ £100m stock online
- ✓ Manage your account online
- ✓ Build jobs lists & save carts
- ✓ View order history
- ✓ Check and print invoices



Online Offers

Weekly email promotions – make sure you've opted in!

[rexel.co.uk](https://www.rexel.co.uk)

Vive by Lutron

Vive is a wireless, networked commercial lighting control system for new and existing commercial buildings.

Vive offers solutions for every space and budget, allowing you to customise control to each space in your building without locking you into more or less control than you need, and provides a scalable solution that accommodates your needs now and into the future. This provides the ability to start in one space and add more controls over time without rewiring or reprogramming.

The following components work together to control the light in your space:



Create a Vive System in 4 Simple Steps

Step 1

PowPak load controllers

Choose your load controller(s)

PowPak wires directly to a marshalling box or adaptable box.



Dimensions

W: 72 mm (2.89")
H: 87 mm (3.44")
D: 32 mm (1.25")

In-line dimmer mounts above a ceiling in line with the loads.



Dimensions

W: 46 mm (1.8")
H: 153 mm (6.0")
D: 32 mm (1.25")

Order No.	Model No.	Capacity	Load Type
2501017087	RMKS-5R-DV-B	5A	SWITCHING (ANY LIGHTING LOAD TYPE)
2501017091	RMKS-16R-DV-B	16A	
2501017089	RMKS-8T-DV-B	8A / 60MA	DIMMABLE 0-10V
2501143874	RMKS-DAL4-SZ	4 DALI DRIVERS	DIMMABLE DALI-2
2501143875	RMKS-DAL32-SZ	32 DALI DRIVERS	
2501017093	RMKS-CC01-24-B	1A/24V DRY CONTACTS	NO/NC MAINTAINED DRY CONTACT CLOSURE
2501293152	RMKS-250-NE	150W	PHASE DIMMABLE: LED
		250W	INCANDESCENT, HALOGEN, ELV

Step 2

Choose wireless remotes for personal control

You can mount a Pico remote on a wall (without cutting holes/chasing cable) or place it on a tabletop.

Remotes



On/off

Wallplates



Single column plate shown with wireless remote attached. Remote sold separately

Pedestals



Single Pedestal shown with wireless remote attached. Remote sold separately

Pico wireless remotes*

10-year battery life

Order No.	Model No.	Options
2501120323	PK2-2B-TAW-L01	ON/OFF
2501120334	PK2-2BRL-TAW-L01	ON/OFF WITH RAISE LOWER
2501120344	PK2-3B-TAW-L01	ON/OFF AND PRESET
2501120345	PK2-3BRL-TAW-L01	3-BUTTON WITH RAISE LOWER
2501017033	PK2-4B-TAW-L31	4-BUTTON SCENE CONTROL
2501017029	PK2-4B-TAW-L01	4-BUTTON ZONE RAISE LOWER

Accessories

Order No.	Model No.	Options
2500923796	LPFP-S1-TAW	1-COLUMN WALLPLATE
2500923797	LPFP-S2-TAW	2-COLUMN WALLPLATE
2500530991	L-PED1-WH	PEDESTAL FOR ONE PICO REMOTE
2500530993	L-PED2-WH	PEDESTAL FOR TWO PICO REMOTES

*Faceplates and pedestals sold separately, additional colour options available

Step 3

Add wireless sensors to your job



Occupancy/
Vacancy sensors
Wall/Corner/
Hallway mount



Occupancy/
Vacancy sensors
Ceiling mount



Daylight sensor
Ceiling mount

Sensors

10-year battery life

Order No.	Model No.	Options
2500578671	LRF3-OCR2B-P-WH	OCCUPANCY/VACANCY
CEILING MOUNT, 360° COVERAGE VARIES BY CEILING HEIGHT		
2500578674	LRF3-OWLB-P-WH	OCCUPANCY/VACANCY
WALL MOUNT, 180° 139.4M2 (1,500 FT2)—MINOR MOTION 278.7M2 (3,000 FT2)—MAJOR MOTION		
2500578673	LRF3-OKLB-P-WH	OCCUPANCY/VACANCY
CORNER MOUNT, 90° 113.8M2 (1,225 FT2)—MINOR MOTION 232.2M2 (2,500 FT2)—MAJOR MOTION		
2500578672	LRF3-OHLB-P-WH	OCCUPANCY/VACANCY
CORRIDOR SENSOR. LONG NARROW FIELD OF VIEW UP TO 45M. COVERAGE VARIES BY CORRIDOR WIDTH AND LENGTH		
2500531066	LRF3-DCRB-WH	DAYLIGHT
CEILING MOUNT, MOUNTING HEIGHT SHOULD BE BETWEEN 1.6 AND 2.4 M. 3.7 M IS THE MAXIMUM MOUNTING HEIGHT ALLOWED.		

Step 4 - optional

Add Intelligence



Vive hub

Order No.	Model No.	Options
2500531066	LRF3-DCRB-WH	BASIC (75 DEVICES) FLUSH MOUNT
2501017079	HKS-2-FM	PREMIUM (700 DEVICES / API/ BACNET) FLUSH MOUNT

RA2 Select by Lutron

Lutron RA2 Select provides personalised smart lighting and shade control for any home and any budget.

Why RA2 Select?

Simple. App-based setup, control, and monitoring; no training or PC required.

Reliable. Like all Lutron products, RA2 Select is 100% end-of-line tested before it leaves our facilities.

Affordable. Easy installation (no cutting holes or chasing cable) and automatic programming means completing an entire job in one visit.



Create a RA2 System in **3** Simple Steps

Step **1**

Add the main repeater

Contractor setup in the Lutron App means you can bypass the homeowner registration process and quickly configure the system.



Repeater

Repeaters

Order No.	Model No.	Options	Description
2501128135	RRK-SEL-REP2-BL	MAIN REPEATER	ALLOWS FOR SETUP, CONTROL, AND MONITORING OF MULTIPLE DEVICES
2501128136	LK-REPPRO-BL	WIRELESS REPEATER	USE UP TO FOUR TO EXTEND THE RF RANGE

Step 2

Add dimmer/switches and control the lights

Install in-line dimmer/switch in the ceiling void at the start of the lighting circuit or in a cupboard (to suit your project) for each light or group of lights to be controlled together. For table and floor lamps, simply plug the dimmer into a 13A socket.



Dimmers and switches

Plug-in lamp dimmer

Dimmers and switches

Order No.	Model No.	Options
2501128138	RRK-R25NE-240	1A/150W LED IN-LINE RF DIMMER 250W INC/HAL/ELV
2501128137	RRK-R6ANS-240	6 A IN-LINE RF SWITCH
2500975716	LMK-16R-DV-B	16 A RELAY MODULE
2500975717	LMK-5T-DV-B	0-10 V DIMMING MODULE
2501306226	RRK-P20-240G-BL	1A/150W PLUG-IN LAMP DIMMER 200W INC/HAL

Step 3

Choose wireless remotes for personal control

You can mount a Pico remote on a wall (without cutting holes/chasing cable) or place it on a tabletop.



2-button scene keypads

4-button scene keypads



1-column wallplate



Pico remote pedestal

Pico wireless controls

Order No.	Model No.	Options
2501017101	PK2-2B-TAW-P01	ENTRY SCENE KEYPAD
2501017103	PK2-2B-TAW-P02	BEDSIDE SCENE KEYPAD
2501017046	PK2-4B-TAW-P01	LIVING ROOM SCENE KEYPAD
2501017048	PK2-4B-TAW-P02	KITCHEN SCENE KEYPAD
2501017050	PK2-4B-TAW-P03	ANY ROOM SCENE KEYPAD
2501120323	PK2-2B-TAW-L01	ON/OFF ZONE REMOTE
2501120334	PK2-2BRL-TAW-L01	ON/OFF WITH RAISE LOWER ZONE REMOTE
2501120345	PK2-3BRL-TAW-L01	3-BUTTON WITH RAISE LOWER ZONE REMOTE
2501017029	PK2-4B-TAW-L01	4-BUTTON ZONE CONTROL ZONE REMOTE

Accessories

Order No.	Model No.	Options
2500923796	LPFP-S1-TAW	1-COLUMN WALLPLATE
2500923797	LPFP-S2-TAW	2-COLUMN WALLPLATE
2500530991	L-PED1-WH	PEDESTAL FOR ONE PICO REMOTE
2500530993	L-PED2-WH	PEDESTAL FOR TWO PICO REMOTES

Integration partners

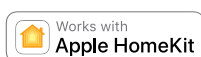

Our Commitment

Rexel UK Ltd is committed to ensuring that we conduct our business in a responsible and sustainable manner. We believe, it is essential to the ongoing success of our business, that our customers, suppliers, employees and the wider community are confident we operate with a high standard of business integrity.

Corporate Responsibility at Rexel UK takes the form of five commitments:

1. Our Products and Customers

Rexel aims to help its customers, large and small, make the best choices for their organisation to maximise the environmental, social and financial benefits associated with their choice of product. We provide customers with information on the energy performance and whole life costing of relevant products and try to deliver our service with as little environmental impact as we can.

2. Our Branches and Operations

Rexel manages most of their CSR impacts with certified ISO management systems. This means we have annual targets to reduce our use of energy, waste, packaging and transport and our performance is independently measured. We are always looking for new ways to improve and innovate and are happy to share our learning with our customers, suppliers and the communities in which we work.

3. Working with our Suppliers

Rexel aims to work closely with its suppliers to improve the whole life costing of products and to reduce the environmental and social impacts caused by their manufacture and use. We are always looking for partnerships where we can develop opportunities for improvement and innovation.

When choosing new suppliers with which to work, Rexel looks to trade with businesses that have similar values. We ask that our suppliers work in a manner that supports us towards meeting our CSR targets and that they operate with integrity and be an asset to the communities in which they are based.

4. Working with Local Communities

Rexel provides local employment, uses regionally based contractors whenever possible and actively supports training opportunities, thereby helping the local economy wherever a Branch is based. Where possible, Rexel will also work in partnership with its customers to help them achieve their community goals. Rexel Branches also support local charities, sports clubs and other community organisations. Branches are also encouraged to propose local projects, that increase access to energy efficiency and reduce fuel poverty, for funding by the Rexel Foundation.

5. Supporting Our Employees

Rexel strives to deliver a safe and healthy working environment and a working culture that respects all colleagues and supports them, when they are in need. We train Managers to lead by example, coach for success and empower their teams. We are always looking for ways to recognise and celebrate excellent performance.

Our certification

Rexel holds certification against the ISO standards for Energy Management (ISO50001), Environmental Management (ISO14001), Quality Management (ISO9001) and Health & Safety Management (ISO45001). The standards cover all our operations in the UK. ISO14001 and ISO50001 have embedded strategic management of energy and environmental aspects into business processes and have annual objectives aimed at reducing Rexel's carbon footprint.



Reducing Rexel's global carbon footprint

Where applicable our ISO targets contribute to the Group Objective of reducing the Group carbon footprint by 35% by 2030 against a 2016 benchmark.

Find out more about how we are continuing to improve our environmental performance at www.rexel.com



Branch Name	Tel	Postcode
ABERDEEN	01224 222 700	AB23 8FE
ABINGDON	01235 533733	OX14 1RL
AIRDRIE	01236 779 080	ML6 9BG
ANDOVER	01264 351 117	SP10 3ZL
ARBROATH	01241 431 881	DD11 1RU
AYR	01292 280 880	KA8 8DT
AZTEC WEST	01454 617 666	BS32 4EU
BALHAM	02086732225	SW12 0PS
BANGOR CAERNARFON ROAD	01248 370093	LL57 4SU
BANGOR LLANDEGAI	01248 355 665	LL57 4HY
BARKING	0330 045 0604	IG11 0AS
BARNSTAPLE	01271 324 300	EX32 8PA
BARROW	01229 835773	LA14 5UG
BASILDON	01268 524085	SS14 3EH
BASINGSTOKE	01256 479174	RG22 4DQ
BATH	01225 428468	BA2 3QS
BEDFORD	01234 215222	MK41 9RX
BELFAST	02890 781157	BT3 9BW
BERMONDSEY	0207 231 4455	SE1 5AN
BERNERS STREET	0207 637 5393	W1T 3BY
BIDEFORD	01237 422300	EX39 3HN
BIRKENHEAD	0151 666 1527	CH41 9HH
BIRMINGHAM INDUSTRIAL	0121 380 0960	B7 4SN
BIRMINGHAM LICHFIELD ROAD	0121 328 7070	B6 5SN
BIRMINGHAM MAPLE BUSINESS PARK	0121 328 9000	B7 5ET
BLACKBURN	01254 582576	BB1 1DJ
BLACKPOOL	01253 595 000	FY2 0FY
BLYTH	01670 540666	NE24 5TW
BOOTLE	0151 933 4624	L20 8BH
BOSTON	01205 351554	PE21 9HG
BRADFORD INDUSTRIAL	01274 735329	BD4 7NE
BRADFORD ROWAN TRADE PARK	01274 305646	BD4 8TQ
BRAINTREE	01376 552916	CM7 2YN
BRENTWOOD	01277 223481	CM13 1TA
BRIDGEND	01656 668828	CF31 3SH
BRIDGWATER	01278 444515	TA6 4AE
BRIGHTON	0330 045 0800	BN3 7BA
BRISTOL KINGSLAND	0117 300 3800	BS2 0JX
BRISTOL VALE LANE	0117 9667081	BS3 5SA
BROMLEY	0208 2906028	BR1 2WD
BROMSGROVE	01527 558774	B60 3EX
BURNLEY	01282 427731	BB11 5SX
BURTON ON TRENT	01283 567077	DE14 1SG
BURY ST EDMUNDS	01284 767231	IP32 7AB
CAMBRIDGE COWLEY ROAD	01223423204	CB4 0DL
CANARY WHARF	0207 537 6330	E14 9UB
CANTERBURY	01227 456771	CT1 1DX
CARDIFF OCEAN PARK	029 20495831	CF24 5PB
CARMARTHEN	01267 233535	SA31 3RB
CHANDLERS FORD	02380 267 411	SO53 4ZJ
CHELTENHAM	01242227555	GL51 8LZ
CHICHESTER	01243 280001	PO19 8UE

Branch Name	Tel	Postcode
CHESTER	01244 682800	CH4 8RJ
CHESTERFIELD	01246 209781	S40 2TZ
CHIPPENHAM	01249 656127	SN14 6LH
CIRENCESTER	01285 640090	GL7 1YE
COLCHESTER	01206 797333	CO2 8HE
COLERAINE	028 7034 3329	BT52 2DH
CORBRY	+44 (0)153	NN17 5DP
COVENTRY	02476681221	CV6 5NX
CRAWLEY	01293 843594	RH10 9RW
CRAYFORD	01322 523222	DA1 4AL
CREWE	01270 588128	CW1 6FA
CROYDON	0208 665 1355	CR0 3JX
DEESIDE INDUSTRIAL	01244 288094	CH5 2NY
DERBY	01332 341831	DE24 8JP
DONCASTER	01302 325589	DN2 4LP
DUDLEY	01384 418900	DY5 1UF
DUMBARTON	01389 764200	G82 2RP
DUNDEE	01382 884151	DD2 3XD
DUNFERMLINE	01383 413401	KY11 2SL
DUNSTABLE	01582475111	LU5 4JY
DURHAM	0191 386 6841	DH1 1TF
EAST GRINSTEAD	01342 324 325	RH19 1XZ
EAST HAM	0207 4742622	E6 6LP
EASTBOURNE HARGREAVES ROAD	01323 512000	BN23 6QW
EBBW VALE	01495 304040	NP23 5SD
EDINBURGH BANKHEAD DRIVE	0131 453 5182	EH11 4DW
EDINBURGH SEAFIELD WAY	0131 657 8470	EH15 1TB
EDINBURGH STENHOUSE MILL WYND	0131 443 8976	EH11 3XX
ELLESMERE PORT	0151 3571757	CH65 3AS
ENFIELD	0208 3647537	EN3 7TY
EXETER	01392257135	EX2 8QW
FALKIRK	01324 624949	FK2 9EG
FAREHAM	01329 221011	PO14 1TP
FARNHAM	01252 726100	GU9 9PR
FELTHAM	0208 751 1234	TW13 7ES
FOLKESTONE	01303 220904	CT19 5FG
FORT WILLIAM	01397 705 794	PH33 6PR
GALASHIELS	01896 753040	TD1 1PR
GATESHEAD METRO RIVERSIDE PARK	0191 495 1000	NE11 9DJ
GATESHEAD TEAM VALLEY	01914 878371	NE11 0HZ
GILLINGHAM	01634373881	ME8 0PP
GLASGOW DEVON PLACE	0141 429 6282	G41 1RB
GLASGOW HARMONY COURT	0141 445 2411	G51 3HN
GLASTONBURY	01458 835800	BA6 9LZ
GLOUCESTER	01452 308300	GL2 5HY
STOKE INDUSTRIAL	01782 204224	ST1 5NP
GRANTHAM	01476 567377	NG316HN
GRAVESEND	01474 320800	DA11 8HL
GREAT YARMOUTH	01493 419500	NR31 0LU
GUILDFORD	01483 537754	GU2 8YT
HAMILTON	01698 282728	ML3 9AZ
HARLOW	01279 417171	CM20 2HU

Registered Office

Rexel UK Ltd, Eagle Court 2, Hatchford Brook, Hatchford Way, Sheldon, Birmingham B26 3RZ

Tel: +44 (0) 121 366 1000

www.rexel.co.uk

Company Registration Number 434724

Branch Name	Tel	Postcode	Branch Name	Tel	Postcode
HARROGATE	01423 886 338	HG2 7HW	PORTSMOUTH	023 9266 9711	PO3 5RU
HEATON	0191 276 9300	NE6 5XB	PRESTON	01772 654 954	PR1 5DP
HENDON	0208 203 0055	NW9 6AQ	READING	0118 941 3141	RG30 6AQ
HIGH WYCOMBE	01494 443844	HP11 1LP	REDHILL	01737769055	RH1 2LP
HUDDERSFIELD	01484 543131	HD1 5DG	REDRUTH	01209 219800	TR15 3RR
HULL	01482 586 555	HU8 8BT	ROCHDALE	01706 759477	OL12 0HA
ILFORD	02085038866	IG3 8RN	ROCHESTER	01634 290475	ME2 4LX
ILKESTON	0115 932 9499	DE7 8EF	ROMFORD	01708 374216	RM3 8UB
INVERNESS	01463 221 881	IV1 1FF	RUNCORN	01928 578141	WA7 4US
IPSWICH	01473 748 431	IP1 5BL	SALFORD	0161 872 4224	M5 3GR
ISLINGTON	02076099941	N7 9HD	SALFORD INDUSTRIAL	0161 786 3228	M5 4TH
KENDAL	01539 740588	LA9 6LU	SALISBURY	01722336636	SP2 7HL
KENTISH TOWN	02072675052	NW5 3EW	SCUNTHORPE	01724 281 363	DN16 1DQ
KIDDERMINSTER	01562 755852	DY11 7QP	SEVENOAKS	01732 410300	TN14 5EL
KINGS LYNN	01553 760611	PE30 4JP	SHEFFIELD	0114 2413450	S4 7UR
KIRKCALDY	01592 200111	KY2 5LJ	SHIRLEY	0121 745 5564	B90 3AX
LANCASTER WHITE CROSS	01524 32323	LA1 4XS	SHREWSBURY	01743 463352	SY1 3TG
LEEDS LATCHMORE IND PARK	0113 3895150	LS12 6DN	SIDCUP	0208 3020901	DA14 5AJ
LEICESTER	0116 285 5555	LE2 7SR	SLOUGH	01753 691616	SL1 4HB
LERWICK	01595 693305	ZE1 0DG	SOUTHAMPTON	023 80725670	SO15 0AD
LICHFIELD	01543 254585	WS14 9UX	SOUTHAMPTON CITY IND PARK	02380228300	SO15 1HG
LIVERPOOL	0151 261 0077	L6 1NA	SOUTHEND	01702 617222	SS2 5TE
LIVINGSTON	01506 634689	EH48 2FY	SPALDING	01775 713633	PE11 3ZN
LONDON CITY	020 7253 6162	ECT1V 3QU	STIRLING	01786 449644	FK7 7UW
LUTON	01582 416633	LU1 1LP	STOCKPORT	0161 429 7171	SK1 3UE
MAIDSTONE QUARRY WOOD	01622 790735	ME20 7XB	STOCKTON	01642 260700	TS18 2QZ
MANCHESTER	0161 2302050	M11 2NB	STOKE ON TRENT HANLEY	01782 213 914	ST1 5NP
MANSFIELD	01623 645150	NG18 5ES	STOKE PHOENIX PARK	01782 262141	ST3 2JD
MIDDLESBROUGH	01642 210351	TS1 5JP	STROUD	01453 755300	GL5 3NL
MILTON KEYNES	01908 379 601	MK1 1JW	SWANSEA	01792 630200	SA1 5JR
MOTHERWELL	01698 843430	ML4 3NP	SWINDON	01793514300	SN2 1ED
NEWBURY	01635 41500	RG14 2DQ	TAMWORTH	01827 312244	B79 7XD
NEWPORT	01633 256 901	NP20 5NS	TAUNTON	01823 336 300	TA2 8RX
NEWPORT (IOW)	01983 523481	PO30 5FA	TELFORD	01952 292192	TF3 3BJ
NEWTON ABBOT	01626 355975	TQ12 4PB	TIDWORTH	01980 847563	SP9 7QD
NORTHAMPTON	01604 752300	NN5 5HL	TREFOREST	01443 843113	CF37 5UA
NORWICH SWEETBRIAR	01603 486515	NR3 2BT	TUNBRIDGE WELLS	01892544666	TN2 3EN
NORWICH WHITE LODGE	01603 788000	NR4 6DG	WAKEFIELD	01924 381281	WF1 5QN
NOTTINGHAM CLARKE ROAD	0115 986 9111	NG2 3JH	WARRINGTON	01925 714608	WA5 7UW
NOTTINGHAM QUEENS DRIVE	0115 986 6531	NG2 1NA	WELLINGBOROUGH	01933 679009	NN8 6ZB
OBAN	01631 565 858	PA34 4PL	WHITEHAVEN	01946 61232	CA28 8EA
OLDHAM	0161 626 0990	OL9 9LH	WIGAN	01942 492211	WN3 4DP
ORKNEY	01856 876876	KW15 1GE	WISBECH	01945 583712	PE13 2RQ
OXFORD BOTLEY	01865 724871	OX2 0JT	WITNEY	01993 702010	OX28 4FH
OXFORD COWLEY	01865 717553	OX4 6NH	WOKING	01483 722422	GU22 9LD
PARK ROYAL	02089657788	NW10 7UA	WOLVERHAMPTON	01902 451654	WV1 2SS
PEMBROKE DOCK	01646 682254	SA72 4RS	WORCESTER	01905 730910	WR4 9GN
PENRITH	01768 892424	CAT1 9BL	WREXHAM	01978 291747	LL13 8DT
PETERBOROUGH	01733 563261	PE1 5XW	YATE	01454 322420	BS37 5YS
PLYMOUTH CATTEDOWN	01752 669788	PL4 0NT	YEOVIL	01935 432 300	BA20 2TJ
PLYMOUTH PHOENIX BUSINESS PARK	01752 737575	PI6 7PY	YORK	01904 647031	YO31 7UU
POOLE	01202 739300	BH12 3LL			

Branch details correct at time of going to print (August 2021)



a world of energy

Order by 12 noon for

Same
day delivery 

Order by 5pm for

Next
day delivery
nationwide 

200+
branches 

Click
& Collect 

REXEL

a world of energy